

## About this Manual

We've added this manual to the Agilent website in an effort to help you support your product. This manual is the best copy we could find; it may be incomplete or contain dated information. If we find a more recent copy in the future, we will add it to the Agilent website.

## Support for Your Product

Agilent no longer sells or supports this product. Our service centers may be able to perform calibration if no repair parts are needed, but no other support from Agilent is available. You will find any other available product information on the Agilent Test & Measurement website, [www.tm.agilent.com](http://www.tm.agilent.com).

## HP References in this Manual

This manual may contain references to HP or Hewlett-Packard. Please note that Hewlett-Packard's former test and measurement, semiconductor products and chemical analysis businesses are now part of Agilent Technologies. We have made no changes to this manual copy. In other documentation, to reduce potential confusion, the only change to product numbers and names has been in the company name prefix: where a product number/name was HP XXXX the current name/number is now Agilent XXXX. For example, model number HP8648A is now model number Agilent 8648A.

---

# User and Service Guide

Publication Number 54620-97011  
October 1995 (pdf version Dec 1998)

For Safety Information, Warranties, and Regulatory information,  
see the pages behind the Index.

© Copyright Hewlett-Packard Company 1994, 1995  
All Rights Reserved

---

## HP 54620A/C Logic Analyzer

---

## The HP 54620A/C at a Glance

### Display shows the current input signals and much more

- Up to sixteen (16) channels in normal or delayed mode
- Indicators for glitch or normal acquisition, time base, channel activity, trigger and acquisition status
- Softkey labels
- Measurement results
- Color Palettes

### Channel Controls select, position, and label inputs

- Turn channels on or off individually or in groups of 8
- Rearrange order of channels to group related signals
- Create and display labels to identify channels, and set channel colors

### General Controls measure, save and restore results, and configure the analyzer

- Measurement keys provide automatic single or dual-channel time and frequency measurements, or use cursors to make manual measurements
- Save or recall measurement configurations or previous results
- Autoscale performs simple one-button setup of the analyzer

### Horizontal Controls select sweep speed and delay parameters

- Sweep speeds from 5 ns/div to 1 s/div
- Delay control moves waveform display to point of interest
- Delayed mode and delay allow zooming in to show a portion of waveform in detail (split screen)

### Storage Keys begin and end data acquisition

- Run/Stop starts and stops continuous acquisitions
- Single performs one acquisition
- Autostore accumulates and displays the results of multiple acquisitions (like persistence on an oscilloscope)
- Erase clears the current acquisition and all accumulated data

### Trigger Keys define what data will be captured by the analyzer

- Edge mode allows triggering on a positive or negative edge (or both) of any single channel
- Pattern mode allows triggering on a pattern of channels either high, low, or don't care, with a single edge qualifier
- Advanced mode allows sequential triggers, combined patterns, patterns and edges, pattern durations, and edge occurrence counts

### Softkeys extend the functionality of command keys

Select measurement types, operating modes, trigger specifications, label data, and more

### Trigger Input/Output

Trigger the HP 54620A/C from other instruments or use the HP54620A/C to trigger other instruments

### Channel Inputs through a flexible probing system

- Sixteen channels through a dual 8-channel cable with micro-grabbers
- Set logiclevels as TTL, CMOS, ECL, or to a user-definable voltage

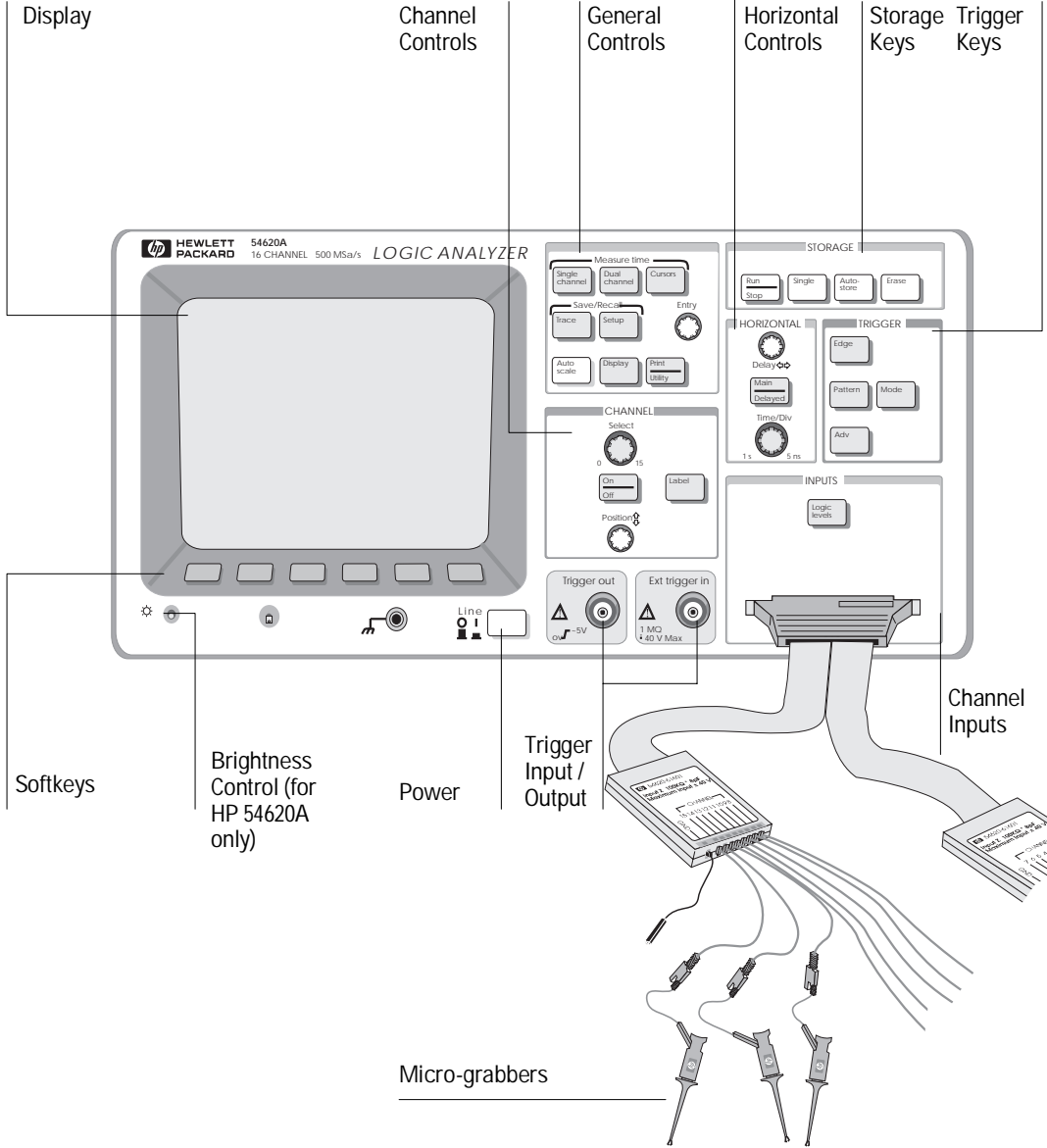

---

## In This Book

The *HP 54620A/C User and Service Guide* is your guide to using the features of the Logic Analyzer in the design and troubleshooting of digital system circuitry.

**Chapter 1**, “Getting Started,” explains how to set up the analyzer and make basic measurements. It also gives an overview of basic analyzer operational concepts including use and interpretation of the front panel and display.

**Chapter 2**, “Making Analyzer Measurements,” shows you how to use the instrument configuration features, measure waveform data, control data acquisition, examine captured data in more detail, set up analyzer trigger conditions, and shows how to use the analyzer with other instruments.

**Chapter 3**, “Solving Problems,” shows you how to fix the most common kinds of problems that might occur when you begin operating the analyzer.

**Chapter 4**, “Ensuring Accurate Measurements,” explains the relationships between the analyzer time base and other time-dependent functions, discusses the effect of probes on measurement accuracy, and explains the glitch detection system. After you have made a few measurements with the HP 54620A/C, it is a good idea to read this chapter.

**Chapter 5**, “Testing, Adjusting, and Troubleshooting the Logic Analyzer,” explains how to test the HP 54620A/C to ensure that it operates correctly. The chapter also shows how adjust and troubleshoot the analyzer.

**Chapter 6**, “Replaceable Parts,” explains how to remove and replace the various assemblies in the analyzer. The chapter also lists the replaceable parts for the analyzer and gives ordering information.

**Chapter 7**, “Performance Characteristics,” lists the measurement performance standards to which the instrument is tested.

**Chapter 8**, “Messages,” lists the status and error messages that may be displayed by the analyzer, explains their causes, and tells what to do to correct the problem.

If you want to automate HP 54620A/C measurements using a programmable controller such as an IBM-compatible PC or an HP 9000 Series 700 controller, see the *HP 54620A/C Programmer’s Guide* and the *HP 54620A/C Programmer’s Reference*. The *Programmer’s Reference* is supplied as a help file on a 3.5" diskette. The diskette includes a help file viewer for Microsoft Windows 3.1, and Microsoft Write editor versions of the files. ASCII files are also supplied.

1	Getting Started	
2	Making Analyzer Measurements	
3	Solving Problems	
4	Ensuring Accurate Measurements	
5	Testing, Adjusting, and Troubleshooting the Analyzer	
6	Replaceable Parts	
7	Performance Characteristics	
8	Messages	
	Glossary	
	Index	



---

# Contents

## 1 Getting Started

Preparing the Analyzer 21

To check package contents 22

To check optional accessories 24

To power-on the logic analyzer 27

To adjust the handle 28

To adjust display brightness 29

Using Color 30

To select the color palettes and observe colors 31

To assign colors to channels 33

To print in color 34

Making Measurements 35

Learn the front panel 35

To probe a circuit 42

To set up an acquisition using Autoscale 44

To start and stop an acquisition 46

To define a simple edge trigger 47

To adjust the time base (sweep speed) 48

To turn channels on and off 49

To rearrange the channels 50

## 2 Making Analyzer Measurements

Setting Logic Levels 53

To change the logic threshold for input signals 54

Controlling Data Acquisition 55

To take a single acquisition 56

To use Auto Glitch Detect 57

To accumulate the results of every acquisition 58

To erase the waveform display 58





### Using Labels 59

- To turn the label display on or off 59
- To assign a label to a channel 60
- To define a new label 62
- To initialize the label list 64

### Triggering the Analyzer 65

- Trigger types 65
- To define the trigger mode 70
- To define an edge trigger 72
- To define a pattern trigger 73
- To define an advanced trigger 74

### Examining the Captured Data 80

- Viewing acquired data with delayed sweep 80
- To show both main and delayed sweep displays 82
- To change the time reference position 83
- To pan the display 86
- To modify the graticule 87
- To print the display 88

### Measuring Waveform Data 89

- Ways to measure data 89
- To use the cursors 94
- To measure waveform parameters on a single channel 96
- To measure channel-to-channel delay 98
- To measure setup time 100
- To measure hold time 102



### Using the Analyzer with Other Instruments 104

- Extending trigger capabilities 104
- To use the external trigger input 108
- To use the trigger output 110

Saving and Recalling the Configuration	111
Using memories to save and recall configurations	111
To save a trace waveform	114
To recall a trace waveform	115
To clear a previously saved trace	116
To save the instrument setup	117
To recall the instrument setup	118
To reset the instrument setup	119

### **3 Solving Problems**

If there is no trace display	123
If the trace display is unusual or unexpected	124
If you can't see a channel	125

### **4 Ensuring Accurate Measurements**

Time base and Acquisition	129
Probing the Circuit Under Test	139
Glitch Detection	143

### **5 Testing, Adjusting, and Troubleshooting the Analyzer**

Testing the Analyzer	151
To perform self-tests	152
To test the keyboard	153
To test the display	154
To test the acquisition system	154
Building Test Accessories	155
To make the test connectors	156
To make the dummy load	158

## Contents

Adjusting the Logic Analyzer	159
To adjust the power supply	160
To adjust the display (HP 54620A only)	162
Troubleshooting the Logic Analyzer	164
To troubleshoot the logic analyzer	165
To check the LVPS	168
Testing Threshold Accuracy	169
Step 1. To set up the equipment	170
Step 2. To connect the logic analyzer	171
Step 3. To test the thresholds	172
Testing Time Interval Accuracy	173
Step 1. To connect the logic analyzer	174
Step 2. To set up the equipment	175
Step 3. To set up the logic analyzer	176
Step 4. To make the measurement	177

## **6 Replaceable Parts**

Removing and Replacing Assemblies	181
To remove the cabinet	182
To remove the fan	183
To remove the front panel	184
To remove the display	185
To remove the system board	186
To remove the power supply	187
To remove the keyboard	188
To remove the handle	189
Replaceable Parts	190
To order a replacement part	191

**7 Performance Characteristics**

**8 Messages**

Messages 209

**Glossary** 217

**Index** 225

**HP 54620 Documentation** 239



---

## Figures

- Figure 1. Using the Logic Analyzer 19
- Figure 1A. Refining the Trigger Specification 20
- Figure 2. Items Supplied with the HP 54620A/C Logic Analyzer 23
- Figure 3. Optional Accessories for the HP 54620A/C Logic Analyzer 25
- Figure 4. HP 54620A Brightness Control 29
- Figure 5. HP 54620C with Label Menu Selected and Single Channel Highlighted 34
- Figure 6. HP 54620A Logic Analyzer Front Panel 36
- Figure 7. HP 54620A/C Display 38
- Figure 8. Sample Autoscale Measurement 44
- Figure 9. Edge Trigger on Channel 0 47
- Figure 10. Logic Threshold Setup 53
- Figure 11. Waveform Display with Auto Glitch Detect Enabled 57
- Figure 12. HP 54620A/C Label Definition Display 61
- Figure 13. Pattern Trigger Setup 67
- Figure 14. Advanced Trigger Setup (with Overview On) 68
- Figure 15. Advanced Trigger Softkeys for Operators with Two Sources 69
- Figure 16. Acquisition Memory 70
- Figure 17. Pulse Train with Constant-Duration Pulse 77
- Figure 18. Sequential Output from State Machine 77
- Figure 19. System Failure on Third Keystroke 78
- Figure 20. Delayed Sweep 81
- Figure 21. Time Reference at Center, Delay of 15  $\mu\text{s}$  on Main Sweep 84
- Figure 22. Delayed Sweep with Delay of 8  $\mu\text{s}$  85
- Figure 23. Measuring the Period of an Irregular Waveform 90
- Figure 24. Single-Channel Measurements 91
- Figure 25. Channel-to-Channel Delay Measurement 92
- Figure 26. Measurement Within the Delayed Sweep Window 93
- Figure 27. Setup Time Measurement 101
- Figure 28. Hold Time Measurement 103
- Figure 29. Connections for External Trigger from an Emulator 105
- Figure 30. Connections for External Trigger using an Oscilloscope Probe 106
- Figure 31. Connections for Triggering an Oscilloscope 107
- Figure 32. Using the External Trigger Input as an Edge Trigger 109

Figure 33. Trace Memory Save/Recall	112
Figure 34. Setup Memory	113
Figure 35. Relationship Between Time base and Analyzer Functions	129
Figure 36. Acquisition Memory	131
Figure 37. Memory Bar	132
Figure 38. Single Acquisition, Time Reference Center, Positive Delay of 75 $\mu$ s	134
Figure 39. Panning the Display to View the Start of Acquisition	135
Figure 40. Single Acquisition, Time Reference Right, Negative Delay of 80 $\mu$ s	136
Figure 41. Panning the Display to View the Trigger Point	137
Figure 42. DC and Low-Frequency Probe Equivalent Circuit	139
Figure 43. High-Frequency Probe Equivalent Circuit	140
Figure 44. Impedance versus Frequency for Both Probe Circuit Models	140
Figure 45. Common Mode Input Voltage Model	141
Figure 46. Glitch Display	144
Figure 47. Aliasing	144
Figure 48. Reconstruction of Waveform with Glitch Capture	145
Figure 49. Waveform Display with Sampling Rate Too Low	146
Figure 50. Waveform Display with Sufficient Sampling Rate	147
Figure 51. Data Output Relative to Clock	148
Figure 52. 8-by-2 Connector Setup	156
Figure 53. 1-by-2 Connector Setup	157
Figure 54. Power Supply Adjustment	161
Figure 55. Display Adjustment	163
Figure 56. Threshold Test Setup	171
Figure 57. Time Interval Accuracy Setup	174
Figure 58. Front Panel Removal	184
Figure 59. Unhooking the Power Switch Shaft	187
Figure 60. Exploded View of Logic Analyzer	192

---

## Tables

Table 1. Power Cords	26
Table 2. Color Palettes and Mapping of Colors to Display Components	32
Table 3. Threshold Voltage Settings	54
Table 4. Trigger Operators and Sources	75
Table 5. Readout Settings	95
Table 6. HP 54620A/C Factory-Preset Default Configuration Settings	119
Table 7. Sweep Speed and Sampling Interval	130
Table 8. Materials Required (Making Test Connectors)	156
Table 9. Equipment Required (Adjusting Power Supply)	160
Table 10. Equipment Required (Adjusting Display)	162
Table 11. Equipment Required (Troubleshooting Logic Analyzer)	164
Table 12. Display Signals	166
Table 13. Equipment Required (Testing Threshold Accuracy)	169
Table 14. Threshold Test Settings	172
Table 15. Equipment Required (Testing Time Interval Accuracy)	173
Table 16. HP 54620A/C Replaceable Parts	193
Table 17. Input channels	197
Table 18. Horizontal System	198
Table 19. Acquisition System	199
Table 20. Trigger System	200
Table 21. Display System	202
Table 22. Measurement Functions	202
Table 23. Setup Functions	203
Table 24. Power Requirements	203
Table 25. General Characteristics for HP 54620A Only	204
Table 26. General Characteristics for HP 54620A and HP 54620C	205
Table 27. General Characteristics for HP 54620C Only	206







Getting Started

---

# Getting Started

When you use the logic analyzer to help test and troubleshoot your systems, you will follow the general process shown in figure 1:

- Prepare the analyzer by connecting it to power and setting up the handle and screen brightness as desired.
- Define the measurement problem by understanding the parameters of the system you wish to test and the expected system behavior.
- Set up channel inputs by connecting the data probes to the appropriate signal and ground nodes in the circuit under test.
- Define the trigger condition by setting the analyzer configuration to capture only the system events you wish to view.
- Use the analyzer to acquire data, either in continuous or single-shot fashion.
- Examine the data and make measurements on it using various analyzer features.
- Save the measurement or configuration for later re-use or comparison with other measurements.

The process is repeated as necessary until you verify correct operation or find the source of the problem.

Figure 1

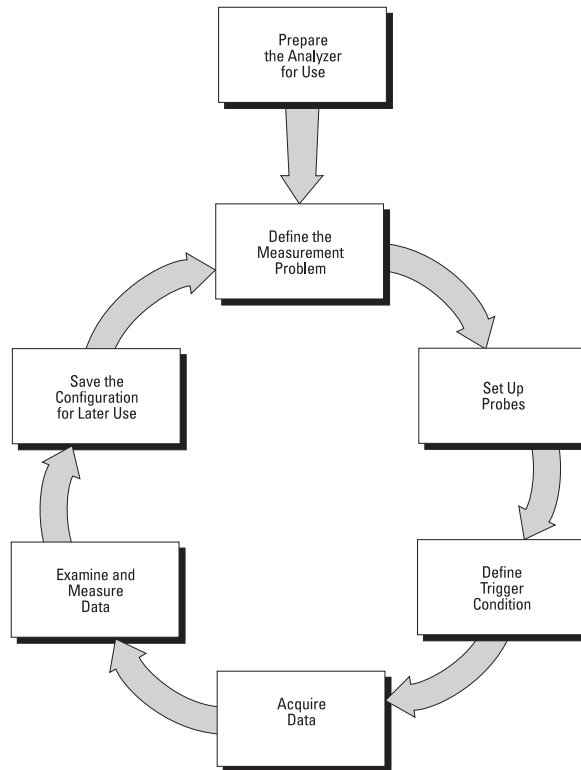

Using the Logic Analyzer

The high-speed display of the HP 54620A/C can be used to isolate infrequently changing signals. You can then use the characteristics of these signals to help refine the trigger specification. See the figure below.

Figure 1A

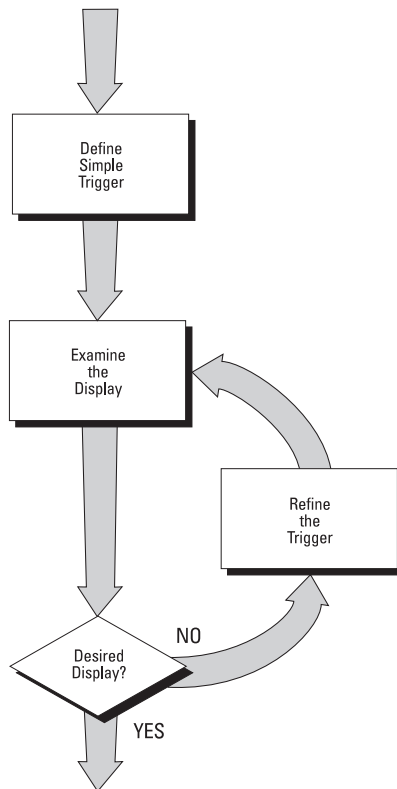

### Refining the Trigger Specification

This chapter discusses analyzer preparation and probe setup, and contains a general introduction to trigger definition and data acquisition. For more information on triggering, data acquisition, data examination and measurement, and configuration, see chapter 2, “Making Analyzer Measurements.”

---

## Preparing the Analyzer

To prepare your logic analyzer for use, you need to do the following:

- 1** Check to ensure that you received everything that is supplied with the analyzer.
- 2** Connect the analyzer to power and switch it on.
- 3** Connect the probe cable to the analyzer and connect probes to the circuit of interest. (You can use the front panel calibration test point as a stimulus while learning to use the analyzer.)

The following pages show you how to do each of these tasks. After you have completed them, you will be ready to use the analyzer.

## To check package contents

- Verify that you received the following items in the HP 54620A/C packaging.  
See figure 2. If anything is missing, contact your nearest Hewlett-Packard Sales Office. If the shipment was damaged, contact the carrier, then contact the nearest Hewlett-Packard Sales Office.
- HP 54620A/C Logic Analyzer.
- Power cord (see table 1).
- HP 54620-61801 16-channel probe cable.
- HP 5090-4356 grabbers (in resealable plastic bag; quantity 20).
- HP 5959-9334 2" ground lead set (quantity 5).
- HP 54620A/C User's Guide.
- HP 54620A/C Programmer's Guide.
- HP 54620A/C Programmer's Reference (3.5" diskette).

Figure 2

HP 54620A/C  
Logic Analyzer

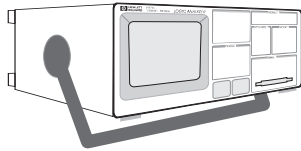

HP 54620-61801  
16-Channel Cable  
(leads attached; with labels)

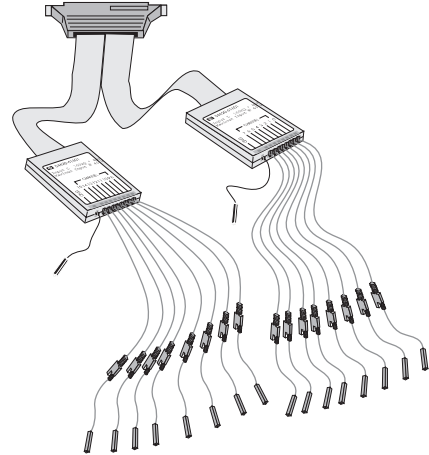

HP 5959-9334  
2" Ground Lead Set (5)



HP 5090-4356  
Grabber (20)



Power Cord  
(Varies depending on country)



HP 54620A/C User's Guide  
HP 54620A/C Programmer's Guide

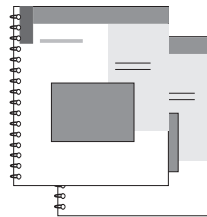

HP 54620A/C  
Programmer's Reference



pkg-cnts.cdr

### Items Supplied with the HP 54620A/C Logic Analyzer



## To check optional accessories

- Verify that you received the optional accessories you ordered.  
See figure 3. If anything is missing, contact your nearest Hewlett-Packard Sales Office. If the shipment was damaged, contact the carrier, then contact the nearest Hewlett-Packard Sales Office.
- Option 101—Front panel dust cover and accessory pouch.
- Option 103—HP 54654A Operator's self-paced Training Kit, including case, manual, and circuit board with battery.
- Option 104—HP 5041-9409 Carrying Case (useful for protecting the instrument in shipment or when checked as airline baggage).
- Option 106—HP 34801A BenchLink software for Microsoft Windows (provides an interface to the instrument from any Windows-compatible PC, allowing the user to save and restore setups and capture measurements for further review).
- Option 001—RS-03 Magnetic Shielding for CRT (HP 54620A only) (not shown in figure 3).
- Option 1CM—Rackmount kit (allows mounting the HP 54620A/C in an EIA-standard rack). This kit is not shown in figure 3.

**Figure 3**

Option 101  
Accessory Pouch and Front Panel Cover

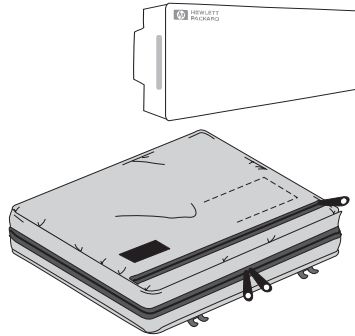

Option 103  
HP 54654A Self-Paced Training Kit

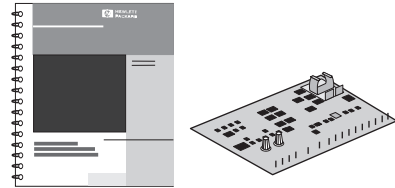

Option 104  
Carrying Case

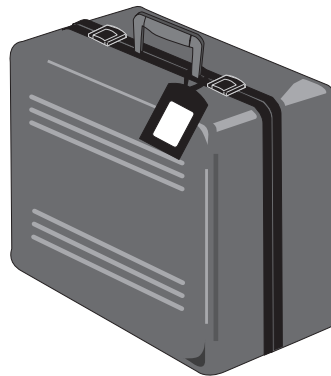

Option 106  
BenchLink/Scope Software for Microsoft Windows

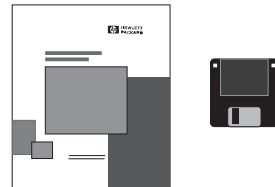









**Optional Accessories for the HP 54620A/C Logic Analyzer**

Getting Started  
To check optional accessories

**Table 1**

**Power Cords**

Plug Type		Cable Part No.	Plug Description	Length in/cm	Color
Opt 903 (U.S.A.) 124V **		8120-1378	Straight (NEMA5-15P*)	90/228	Jade Gray
Opt 900 (U.K.) 250V		8120-1351	Straight (BS136A*)	90/228	Gray
Opt 901 (Australia) 250V		8120-1369	Straight (NZSS198/ASC*)	79/200	Gray
Opt 902 (Europe) 250V		8120-1689 8120-2857	Straight (CEE7-Y11*) Straight (Shielded)	79/200 79/200	Mint Gray Coco Brown
Opt 906 (Switzerland) 250V		8120-2104	Straight (SEV1011*)	79/200	Mint Gray
Opt 912 (Denmark) 220V		8120-2957	Straight (DHCK107*)	79/200	Mint Gray
Opt 917 (Africa) 250V		8120-4600	Straight (SABS164)	79/200	Jade Gray
Opt 918 (Japan) 100V		8120-4753	Straight Miti	90/230	Dark Gray

\* Part number shown for plug is industry identifier for plug only.  
Number shown for cable is HP part number for complete cable including plug.  
\*\* These cords are included in the CSA certification approval for the equipment.

## To power-on the logic analyzer

- 1 Connect the power cord to the rear of the HP 54620A/C, then to a suitable ac voltage source.

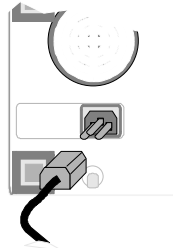

The HP 54620A/C power supply automatically adjusts for input line voltages in the range 100 to 240 VAC. Therefore, you do not need to adjust the input line voltage setting. The line cord provided is matched by HP to the country of origin of order. Ensure that you have the correct line cord. See table 1.

- 2 Press the power switch.

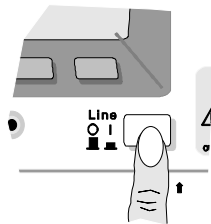

The HP 54620A/C performs a self-test, then shows the display. The instrument is ready to use.

---

## To adjust the handle

- 1** Grasp the handle pivot points on each side of the instrument and pull the pivot out until it stops.

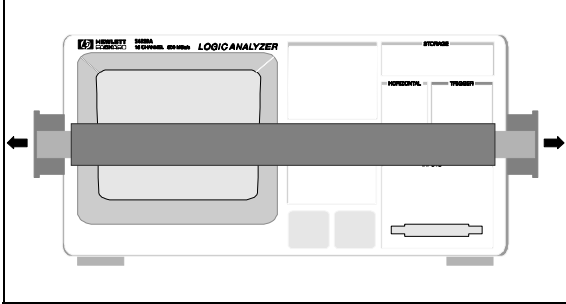

- 2** Without releasing the pivots, swivel the handle to the desired position. Then release the pivots.

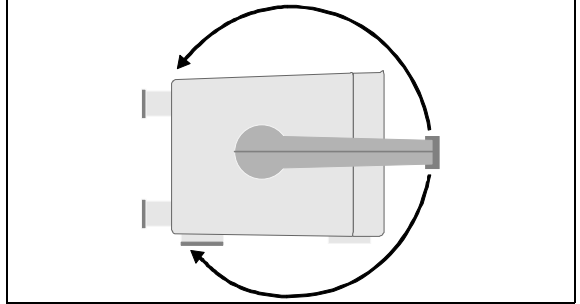

---

## To adjust display brightness

- To decrease display brightness, rotate the brightness control counterclockwise.
- To increase display brightness, rotate the brightness control clockwise.

The brightness control is at the lower left corner of the display. See figure 4.

Figure 4

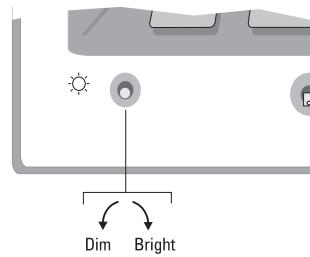

### HP 54620A Brightness Control

The "A" model includes a brightness control. There is no brightness control on the HP 54620C.

---

## Using Color

With the HP 54620C color logic analyzer, you can select any of the seven available color palettes to assign colors to channels, cursors, stored waveforms, and text. You can assign each channel one of four waveform colors.

The seven color palettes allow additional customization, which allows you to easily distinguish between channel waveforms. In addition, when making measurements on a channel, wherever the channel number appears on screen, it is highlighted in the selected color.

The color palettes are individually named, and you can choose the palette that best suits your needs. You can change from the Default palette to any of the following:

- Alternate 1 works well for people who are colorblind.
- The colors in Alternate 2 are compatible with those used in HP 545XX-series oscilloscopes.
- Alternate 3 sets the cursors to yellow.
- Inverse 1 works well for hard copies.
- Inverse 2 works well for overhead transparencies.
- A Monochrome palette is also available.

In each palette, different colors are used for cursors, waveforms, softkeys, and Autostore. The background is always black, unless you select the Inverse palettes, which use a white background. Softkeys and the grid are always in white, except in the Inverse palettes, which set them to black.

This section shows you how to:

- Select the color palettes and observe colors
- Assign colors to channels
- Print in color

---

## To select the color palettes and observe colors

- 1 Press `Display` . Look at the **Palette** softkey.

The name of the palette appears under the softkey. For example, Default.

- 2 Press the **Palette** softkey. Continue to cycle through the palettes and observe colors applied to the cursors, waveforms, and softkeys.

Notice that the softkeys are white in all palettes, except the Inverse palettes, where they are black.

- 3 Press the **Grid** softkey and set the grid to **Full**.

The graticule is always white, except in the Inverse palettes, where it is black.

- 4 Press `Cursors` . Press **Active Cursor t2**.

A single color shows cursors in the display area, the active cursor selected, and the cursor measurement Time and Hex readouts.

- 5 Press `Single channel` . Press the **Freq** softkey, then **Period**.

The current measurement readout is displayed in the cursor color whenever the Show Meas softkey is On in single-channel measurement Next Menu, or in the dual-channel measurement menu. You can toggle the Show Meas keys and see the current measurement change between the cursor color and white.

- 6 Press `Autostore` .

The autostored waveforms are displayed in blue when using the Default and Alternate color palettes, and in cyan in the Inverse color palettes.

- 7 Press `Autostore` to turn it off. Then press `Erase` .

- 8 Press `Edge` . Look at the channel activity indicators.

The activity indicator for each channel is displayed in the same color assigned to the channel. Channel indicators for channels not displayed are white, except in the Inverse palettes, where they are black. If you define an edge trigger, the channel and trigger edge are displayed in the channel color in the upper-right corner of the screen.

- 9 Rotate the Select knob to cycle through through the channels.

The channel number and corresponding activity indicator are both highlighted in the color applied to the channel. For a channel not displayed on the screen, as you rotate the Select knob, that channel number appears in the upper-left corner in the same color applied to the corresponding selected activity indicator.



Getting Started  
**To select the color palettes and observe colors**

The following table shows the color palettes and the palette colors mapped to the display components.

**Table 2**

**Color Palettes and Mapping of Colors to Display Components**

Palette	Color	Display Component	Palette	Color	Display Component
<b>Default</b>	green	cursors	<b>Alternate 3</b>	yellow	cursors
	yellow	waveform1		magenta	waveform1
	magenta	waveform2		cyan	waveform2
	cyan	waveform3		green	waveform3
	red	waveform4		red	waveform4
	white	softkeys		white	softkeys
	white	graticule		white	graticule
	blue	autostore		blue	autostore
black	background	black	background		
<b>Alternate 1</b>	red	cursors	<b>Inverse 1</b>	cyan	cursors
	cyan	waveform1		red	waveform1
	yellow	waveform2		blue	waveform2
	magenta	waveform3		green	waveform3
	green	waveform4		magenta	waveform4
	white	softkeys		black	softkeys
	white	graticule		black	graticule
	blue	autostore		cyan	autostore
black	background	white	background		
<b>Alternate 2</b>	cyan	cursors	<b>Inverse 2</b>	black	cursors
	yellow	waveform1		red	waveform1
	green	waveform2		blue	waveform2
	magenta	waveform3		magenta	waveform3
	red	waveform4		green	waveform4
	white	softkeys		black	softkeys
	white	graticule		black	graticule
	blue	autostore		cyan	autostore
black	background	white	background		

In the monochrome palette, all of the display components are in white, except the background, which is black.

---

## To assign colors to channels

- 1 Press **Label** . Look at the **Assign Channel Colors** softkeys.

The single channel softkey is highlighted in color. This softkey is used to assign one color to a single channel. The softkey just to the left is used to assign one color to a group of channels. The activity indicator for each displayed channel has the same color assigned to the channel.

- 2 Press the single channel softkey, labeled **x CHXX** (where X is the selected channel number). Press it again, and rotate the Select knob to cycle through the channels and select the one you want.

Pressing this softkey increments the channel number.

- 3 Press **Next Color**.

The channel highlights in the selected color. Continue to set as many channels to the colors you want.

- 4 Press **Chan 0-3**. The softkey highlights. Press it a few more times and it changes to **Chan 4-7**, **Chan 8-11**, and **Chan 12-15**.

If all four channels in a group are assigned the same color, the softkey shows that color when you select it. If the channels in the group vary in color, the softkey is white.

- 5 Press **Next Color**. Continue to press this softkey to view the waveform colors currently available.

The channel group softkey appears in the selected color, and the channels in the group, if displayed on the screen, also display in the selected color. Changing the color for a channel group will change the color for all channels in the group, even if not all of the channels are displayed on the screen.

### Colors Coordinate to Display Activity and Selections

When using colors on the HP 54620C color Logic Analyzer, all of the activity for a specific channel, including the channel color assignment softkey, channel waveform, channel activity indicator, and trigger condition indicator (when defined for the same channel) are displayed in the same color on screen.

The following figure shows the HP 54620C with the Label menu selected and the Assign Channel Colors softkeys displayed.

Figure 5

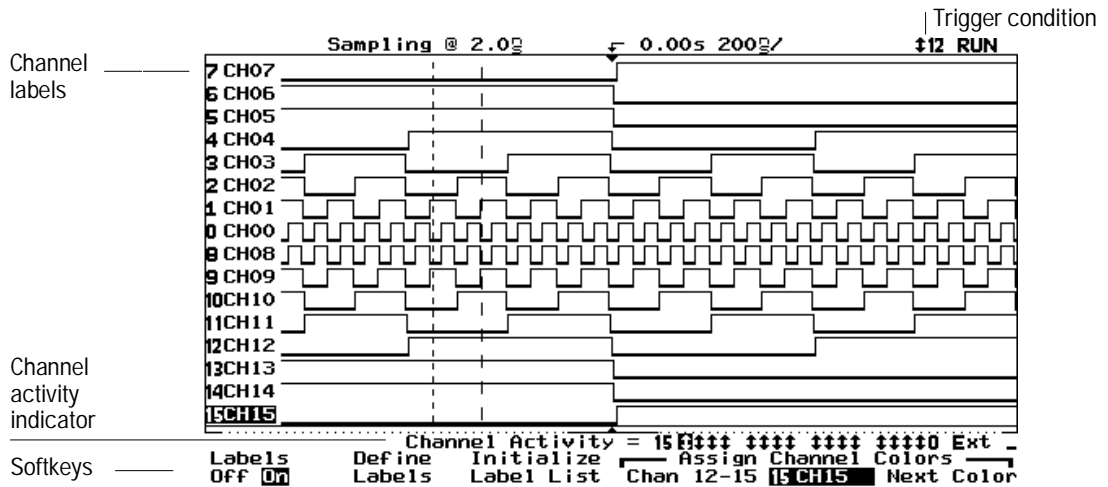

HP 54620C with Label Menu Selected and Single Channel Highlighted

## To print in color

- 1 Press **Print** .

Steps 2-4 are valid if you are using the HP 54652B Interface Module. The HP 54652B is the recommended module for non-HP-IB applications. The HP 54659B will function as a hardcopy and computer I/O, but none of its advanced features are active in the logic analyzer. The HP 54652B and HP 54659B each have dual interfaces (a parallel port and RS-232). If you are using these modules, you can set the Destination to either Parallel or RS232. Because there are no color printers with an HP-IB Interface, the HP 54650A module is not recommended for color printing.

- 2 Press **Hardcopy Menu**. Then press **Format** until it displays **HP DJColor**. This selects the HP DeskJet Color Printer format.
- 3 Set the Destination to **Parallel**.
- 4 Press **Previous Menu**. Then press **Print Screen**.

The current display will be sent out the parallel port to the HP DeskJet color printer attached to your logic analyzer, and printed in color.

To make measurements using the HP 54620A/C, you set up the instrument using front-panel controls, then read the display results.

---

## Learn the front panel

The HP 54620A front panel is shown in the following figure. The HP 54620C differs only in that it does not have intensity control.

### **Front-Panel Functions**

The front panel has several functional groups:

**Display** Shows measurement results, some instrument configuration settings, and shows color palettes (HP 54620C).

**Channel Controls** Move or rearrange channels, turn them on or off, add descriptive labels to them, and assign colors (HP 54620C).

**General Controls** Includes various measurement functions, configuration and measurement result save/recall, printing, and autoscale functions.

**Horizontal Controls** Adjusts the time base, horizontal mode, and delayed sweep functions.

**Storage Keys** Controls start and stop of acquisition, persistent acquisition, and screen erasure.

**Trigger Keys** Sets up analyzer trigger mode and trigger conditions.

**Softkeys** Sets up various options for each major function, varying dynamically depending on the required function.

**Trigger Input / Output** Trigger the HP 54620A/C from external instruments or use the HP 54620A/C to trigger another instrument.

**Signal Inputs** Connects the HP 54620A/C acquisition system to the probes.

Figure 6

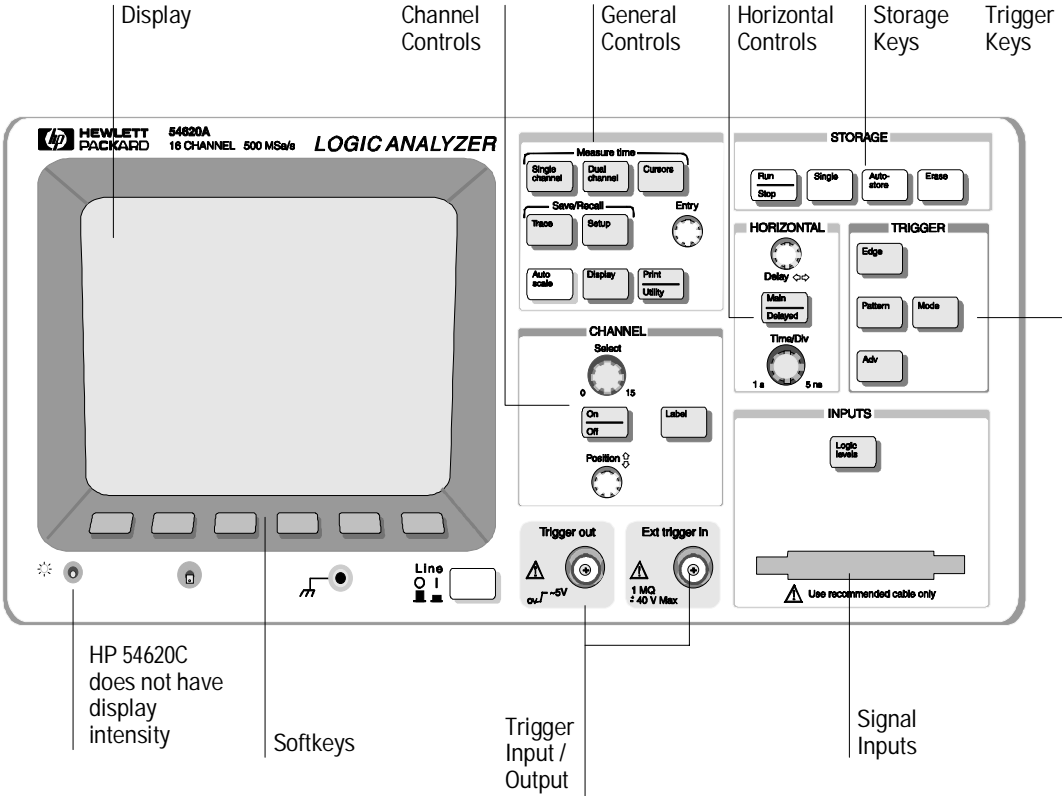

HP 54620A Logic Analyzer Front Panel

## Keypad and Softkeys

There are three types of keys on the front panel:

- White keys have an immediate action, such as starting or stopping the analyzer. There are no menus associated with white keys.
- Gray keys bring up softkey menus, allowing you to modify the instrument's measurement configuration.
- Softkeys under the display dynamically change to indicate currently valid menu selections. Softkeys that are blank (that is, for which there is no corresponding label) have no function in the selected menu.

Some keys, such as `On/Off` and `Label` , also have special functions while in the menus that they activate.

## Control Knobs

The HP 54620A has six control knobs. The HP 54620C has five control knobs; it does not have an intensity control knob.

- The Time/Div knob changes the current time base setting (sweep speed) of the analyzer in Main or Delayed sweep. The setting of the timebase affects sample rate and other analyzer functions as well. See chapter 4, “Ensuring Accurate Measurements,” for more information.
- The Delay knob sets the delay time with respect to the time reference in either Main or Delayed sweep.
- The Select knob chooses the channel on which the next action will operate.
- The Position knob moves the selected channel to a new vertical position on the display.
- The Entry knob selects from multiple choices in menus. It also occasionally duplicates the function of the Select knob.
- The display intensity knob (HP 54620A only—marked only with an intensity symbol) adjusts display brightness.

## Display

This figure shows the HP 54620A/C display.

Figure 7

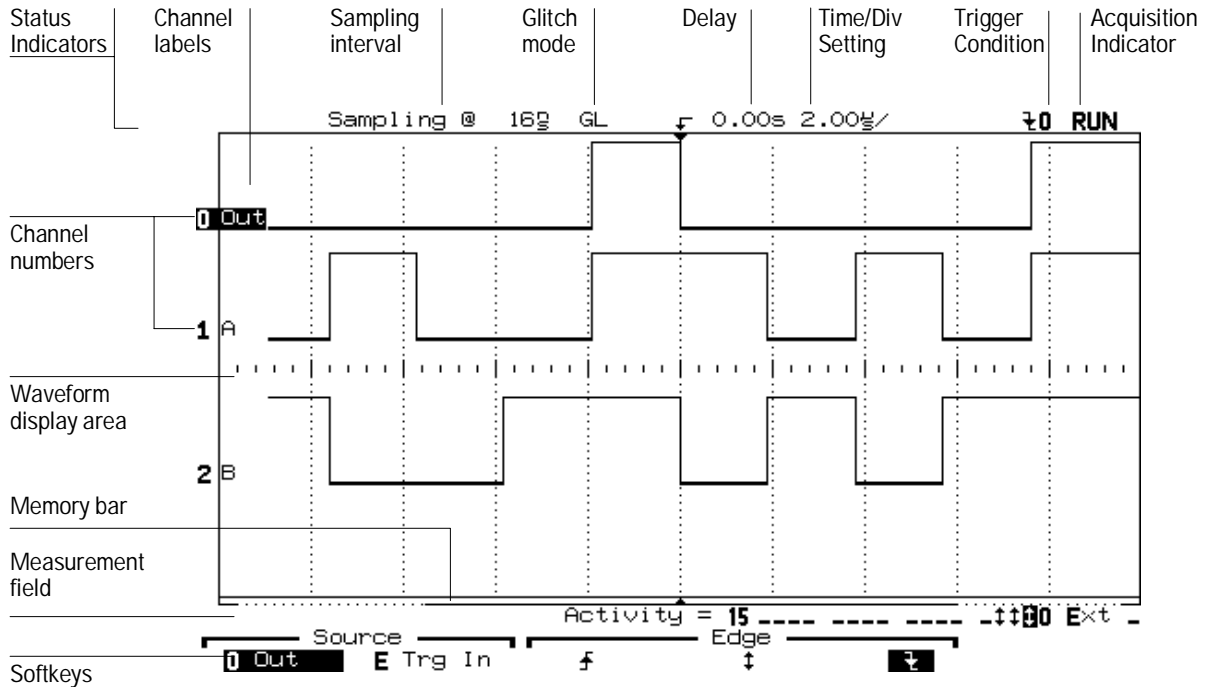

### HP 54620A/C Display

The display is divided into five regions:

- Status indicators are along the top of the display.
- Channel numbers and labels are along the left edge of the display.
- Waveforms are in the center of the display.
- Measurement results and messages are just below the waveform display area.
- Softkey labels are along the bottom of the display.

## Status Indicators

Status indicators include the following:

- Channels that are turned off; these are visible only if you select a channel that is off by using the Select knob.
- Sampling interval is a function of the Time/Div setting and varies from 2 ns to 8 ms.
- Glitch mode is indicated by “GL”, and indicates that glitch detection is enabled. This is automatically enabled for sampling intervals greater than 8 ns. At time base speeds faster than 1  $\mu\text{s}/\text{div}$  (sampling intervals of 4 ms and faster) glitch mode is disabled.
- Delay includes the time reference indicator, the offset markers, and the delay measurement. The time reference indicator is a left arrow ( $\leftarrow$ ) if the trigger event is at the beginning of acquisition memory, a right arrow ( $\rightarrow$ ) if the event is at the end of acquisition memory, and a down arrow ( $\downarrow$ ) if it is at the center. The offset markers and delay measurement work together when you adjust the delay knob and Horizontal Mode is set to Main, to indicate how far you have delayed the trigger event from the initial time reference position.
- Time/Div shows the time base setting. Time per division is variable from 5 ns/div to 1 s/div.
- Trigger condition shows the current trigger mode. For edge trigger mode, it will also show the trigger condition. If the last acquisition was initiated by pressing the Single key, the letters “Sngl” appear in this position (unless the last single acquisition was auto triggered).
- Acquisition indicator shows the current acquisition condition, that is, whether the acquisition system is running, stopped, or in autostore mode.

When the analyzer is in Normal trigger mode, the Trigger condition indicators flash while the analyzer is searching for the trigger condition, which occurs after the pre-trigger buffer is full. When the analyzer is in Auto trigger mode, the word “Auto” flashes to the left of the Trigger condition indicator if the analyzer did not find the trigger and was therefore triggered automatically after a time-out.

The trigger condition indicators might also flash if the analyzer is stopped. This indicates that the analyzer is finding a trigger condition and is driving the trigger out port.



### **Channel Numbers and Labels**

The channel numbers are always shown along the left edge of the display. You can assign channel labels to help you remember the function of each channel in your circuit, or disable the labels to increase the waveform display area. See chapter 2, “Making Analyzer Measurements,” for more information on using labels.

When using the HP 54620C color logic analyzer, you can assign colors to channels using the Label menu. See “Using Color” in this chapter for more information about assigning colors to channels.

### **Waveform Display**

The waveform display area shows all acquisition results. You can change the graticule or turn it off entirely using the Display menu. See chapter 2, “Making Analyzer Measurements.”

When using the HP 54620C color logic analyzer, the waveform display shows all activity and selections pertaining to a particular channel in the color assigned to that channel. See “Using Color” in this chapter for more information about assigning colors to channels.

### **Memory Bar and Measurement Field**

The memory bar is a horizontal line below the waveform display area which shows what fraction of acquisition memory is displayed and the position of the display with respect to acquisition memory. When the analyzer is stopped, you can change the size of the display with respect to acquisition memory using the Time/Div control, allowing you to zoom in on a specific portion of memory.

Below the memory bar is the measurement field. This area is used to display results for single- and dual-channel measurements, activity indicators, trigger settings, error messages, and status messages.

### **Softkeys**

Softkeys are shown along the bottom of the display. Some softkeys have an immediate action, such as taking you to another menu or initiating a measurement.

Other softkeys allow you to scroll through a list of choices, such as channels or trigger operators. You can scroll through the choices by pressing the softkey repeatedly. For some softkeys, you can use the Entry knob to scroll through the choices. For channel lists, you can always use the Select knob or Entry knob to scroll through the choices.

Occasionally a softkey label is displayed with two choices below it, one of which is highlighted. The highlighted choice is the one that is currently active. Pressing the softkey toggles the highlight to the other choice.

When several softkeys are displayed with a labeled bar over them, it means that either the softkeys are related or that the choices are mutually exclusive.

When using the HP 54620C color logic analyzer color palettes, some channel-specific softkeys display the color assigned to the particular channel. See “Using Color” in this chapter for more information about assigning colors to channels.

## To probe a circuit

- 1** Turn off the power supply to the circuit under test.

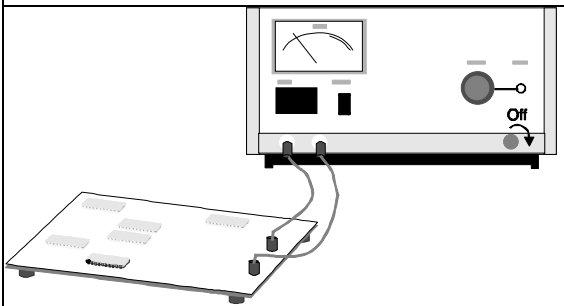

Turning off power to the circuit under test prevents damage that might occur if you accidentally short two lines together while connecting probes. You can leave the HP 54620A/C powered on because no voltage appears at the probes.

- 2** Connect the probe cable to the HP 54620A/C. The cable is indexed so you can connect it only one way. You do *not* need to power-off the HP 54620A/C.

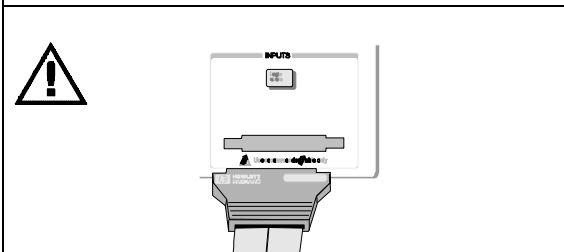

- 3** Connect a grabber to one of the probe leads. (Other probe leads are omitted from the figure for clarity.)

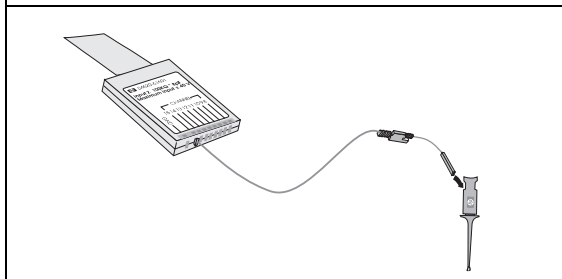

- 4** Connect the grabber to a node in the circuit you want to test.

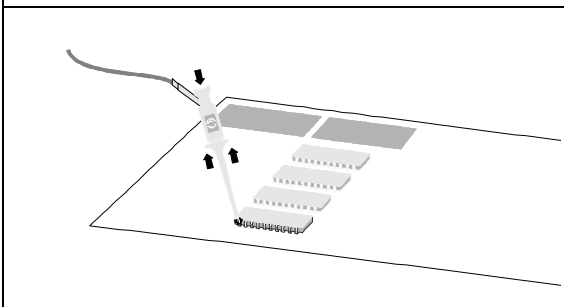

- 5** For high-speed signals, connect a ground lead to the probe lead, connect a grabber to the ground lead, and attach the grabber to ground in the circuit under test.

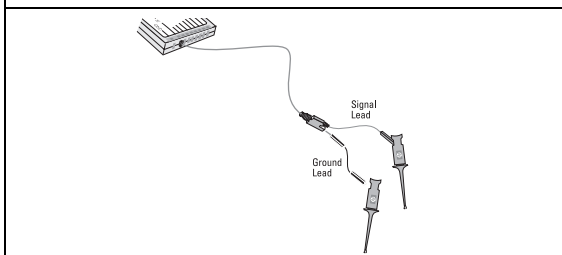

**6** Connect the ground lead on each set of channels, using a probe grabber. The ground lead improves signal fidelity to the analyzer, ensuring accurate measurements.

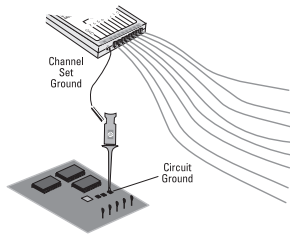

**7** Repeat steps 3 through 6 until you have connected all test points of interest.

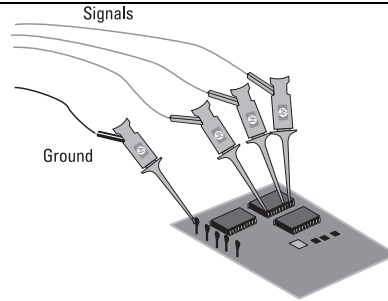

**8** If you need to remove a probe lead from the cable, insert a paper clip or other small pointed object into the side of the cable assembly, and push to release the latch while pulling out the probe lead.

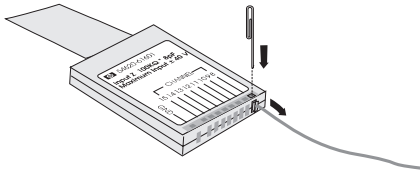

See “Probing the Circuit Under Test” in chapter 4 for information on how probing affects measurement accuracy.

---

## To set up an acquisition using Autoscale

- To configure the analyzer quickly, press **Autoscale** .
- To undo the effects of autoscale, press **Setup** , then press the **Undo Autoscale** softkey in the Setup menu.
- To set the instrument to the factory-default measurement configuration, press **Setup** , then press the **Default Setup** softkey in the Setup menu.

---

### Example

Connect the probes for channels 0, 1, 2, and 3 to the calibration output on the front panel of the logic analyzer. Set the analyzer to the factory default configuration by pressing **Setup** , then **Default Setup**. Then press **Autoscale** . You should see a display similar to the following. Notice that the default trigger condition is a rising edge trigger on channel 0.

Figure 8

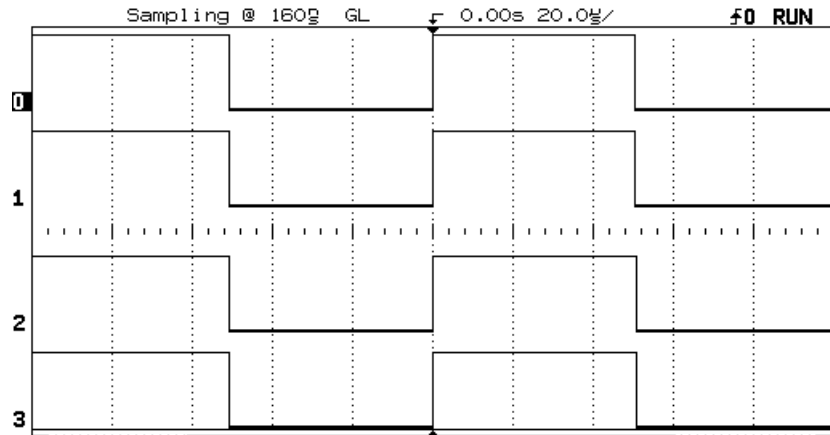

Sample Autoscale Measurement

---

### How Does Autoscale Work?

If there is at least one channel with an active signal, the analyzer turns off all other channels having no activity, that is, where no transitions through the logic threshold are occurring, and turns on all channels having activity. TTL, ECL, and variable thresholds are used while testing for signal activity.

Channels not previously displayed will be added below those channels already being displayed with the lowest numbered channel at the top. Higher numbered channels will be displayed in order down the display. The channels that are on are scaled vertically to best fit the screen.

The analyzer checks for activity using a window of 20 ms, allowing it to recognize signals as slow as 50 Hz for autoscaling. Channels that are turned off will have blank activity indicators in the display. If the analyzer does not find any channel with an active signal, it restores the setup to the pre-autoscale state.

Sweep speed is set to give an optimally scaled display of all the active channels. Autoscaling attempts to find a Time/div setting such that the slowest signal has between 1 and 3 periods displayed, with no more than 125 periods of the fastest signal displayed. If these criteria cannot be satisfied, then a Time/div setting is selected that is as slow as possible, yet shows less than 125 periods of the fastest signal.

Triggering (except for auto/normal mode) and channel labels are not affected, unless an external trigger is found. Delay is set to zero. The analyzer is set to Run mode (continuous acquisition).

The Undo Autoscale function returns the instrument to the setup that existed prior to Autoscale being activated.

When using the HP 54620A/C, pressing Autoscale returns the Auto Glitch Detect capability in the Display menu to the enabled status.

## To start and stop an acquisition

- To begin an acquisition, press the **Run/Stop** key.

The analyzer begins acquiring data while searching for a trigger condition. The RUN indicator is shown in the upper-right corner of the display. If a trigger occurs, the acquired data is shown in the display.

- To stop an acquisition in process, press the **Run/Stop** key.

The analyzer stops acquiring data, and the STOP indicator is shown in the upper-right corner of the display. If the analyzer was triggered (even by auto triggering) and the acquisition buffer is full, the results are displayed on the screen. If the acquisition buffer is not full, the waveform display area will be blank.

See “To define the trigger mode” in chapter 2 for information on how the analyzer trigger mode affects the search for the trigger condition.

## To define a simple edge trigger

- 1 Press **Edge** .
- 2 Do one of the following:
  - Press the **Trg In** softkey under **Source** to choose the External Trigger input as the trigger source.
  - or
  - Select a channel as the trigger source using either the Select knob, the Entry knob, or the softkey.

You can choose a channel that is turned off as the source for the edge trigger.
- 3 Press one of the **Edge** softkeys to choose whether the trigger will occur on the rising edge, falling edge, or either edge of the input signal.

### Example

Connect the probe for channel 0 to the front-panel calibration test point. Then set up a falling edge trigger on channel 0. You should see a stable display as shown below.

Figure 9

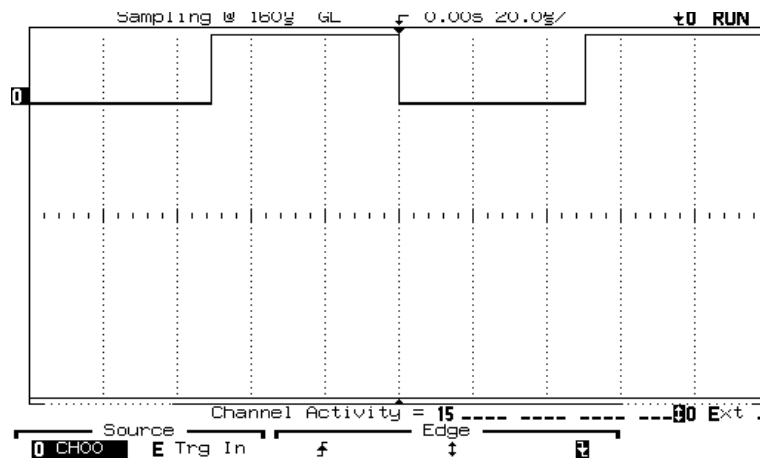

Edge Trigger on Channel 0



## To adjust the time base (sweep speed)

- To increase the sweep speed (decrease the amount of time per division on the display), turn the Time/Div knob clockwise.
- To decrease the sweep speed (increase the amount of time per division on the display), turn the Time/Div knob counterclockwise.

The sweep speed is adjustable from 5 ns/div to 1 s/div in 1, 2, 5 increments. Turning on **Vernier** in the Main/Delayed menu gives finer increments.

When using the HP 54620A/C, and Auto Glitch Detect is disabled, you can adjust the sweep speed to 2 s/div and 5 s/div. "GL" is not displayed if the logic analyzer Auto Glitch Detect is disabled.

The current sweep speed setting affects other instrument operating parameters. For example:

- The sampling period is a function of the Time/div setting, but changes only when a new acquisition begins.
- To avoid missing fast events or short pulses, the analyzer automatically switches to glitch mode at all time base settings slower than 1  $\mu$ s/div. The glitch mode indicator "GL" will appear in the status line.
- In advanced triggering, the minimum limit for a pattern duration trigger is two sample periods. Because the sampling rate depends on the Time/Div setting and Auto Glitch Detect setting, the minimum duration and resolution of the duration will change as the Time/Div setting changes, or as the Auto Glitch Detect setting changes.

See chapter 4, "Ensuring Accurate Measurements," for more information.

---

## To turn channels on and off

- To turn off a specific channel, press **On/Off** , select a channel using the Select knob, then press the leftmost softkey until **Off** is highlighted.
- To turn on a specific channel, press **On/Off** , select a channel using the Select knob, then press the leftmost softkey until **On** is highlighted.

If you are already in the **On/Off** menu, you can press the **On/Off** key to toggle a particular channel on or off. The list of channels that are off is in the upper-left corner of the display. You can also use the first softkey to select a channel when the On/Off softkey menu is present.

- To turn channels 0 through 7 on, press **On/Off** , then press the **On** softkey under “Chan 0 - 7.”
- To turn channels 0 through 7 off, press **On/Off** , then press the **Off** softkey under “Chan 0 - 7.”

A corresponding set of On and Off softkeys is available for channels 8 through 15.

The analyzer does not disable input for channels that are off. It simply does not display those channels. So, you can assign labels to channels that are off or use them in a trigger specification. Also, if you turn a channel on after an acquisition, the data acquired for that channel will be displayed. A channel must be on, though, if you wish to make measurements using the single- or dual-channel measurement features.

## To rearrange the channels

- 1 Turn the Select knob to choose the channel you want to move.**

Only channels that are currently on may be moved.

- 2 Turn the Position knob to choose a new location for the selected channel.**

Turning the Position knob counterclockwise moves the channel down; turning the knob clockwise moves the channel up.

The combination of the Select and Move knobs gives you a feature similar to that of a waveform position control on an oscilloscope, except that you can only move the waveform to certain discrete locations.

You can also change the general order in which channels are displayed. Press On/Off or Display, then press Order to toggle between 0-15 and 15-0 orderings.



## Making Analyzer Measurements

---

# Making Analyzer Measurements

The HP 54620A/C provides a full set of features to help automate your measurement tasks. You can:

- Set up the analyzer for different logic thresholds, allowing simultaneous timing measurements on sets of signals from different logic families.
- Modify the way the analyzer acquires data.
- Label input signals to make it easier to relate the display to the circuit under test.
- Set up simple or complex trigger conditions, as needed, to capture only the sequence of events you want to examine.
- Use delayed sweep to examine the waveforms of interest.
- Make measurements on a single waveform or on one waveform with respect to another.
- Trigger the analyzer from other instruments or use the analyzer to trigger other instruments.
- Save the measurement for comparison with others or save the analyzer configuration for later use in making the same measurement.

This chapter explains how to do all these things and more. If you are not familiar with basic analyzer operations, see chapter 1, “Getting Started.”

# Setting Logic Levels

You can adjust the logic threshold levels used by the analyzer for three independent groups of input signals: channels 0-7, channels 8-15, and the external trigger. Because of this, you can make simultaneous measurements on signals from different logic families. For example, you could connect channels 0-7 to TTL signals, channels 8-15 to ECL signals, and the external trigger to an analog signal. Then, you can set the threshold voltages to the appropriate value for each group.

**Figure 10**

When threshold is set correctly, the activity indicators show double-headed arrows for rapidly-changing signals, or high or low for static or very low-frequency signals

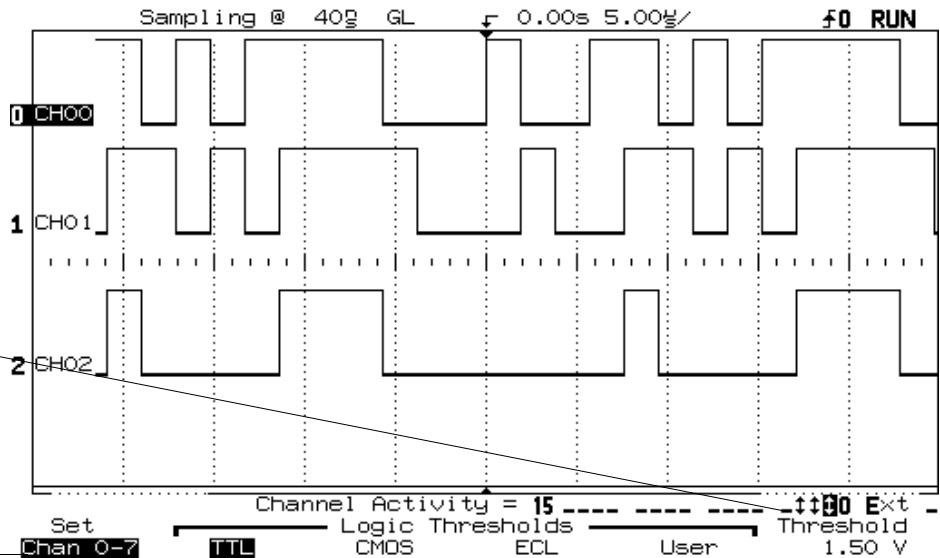

Selects the group of channels for which threshold will be set

Choose from preset TTL, CMOS, or ECL thresholds, or set a user-defined threshold

Shows the threshold for the selected family, or sets a user-defined threshold using the Entry knob

## Logic Threshold Setup

---

## To change the logic threshold for input signals

- 1 Press `Logic Levels` .
- 2 Press the **set** softkey to highlight the range of channels for which you want to set the logic threshold.  
Ranges available are **Chan 0-7** (channels 0 through 7), **Chan 8-15** (channels 8 through 15), and **TRIG IN** (the external trigger input).
- 3 Press **TTL**, **CMOS**, **ECL**, or **User** to select the threshold.
- 4 If you selected **User**, set the threshold voltage using the Entry knob.  
Turning the Entry knob while in this menu automatically sets the Threshold option to **User**.
- 5 Repeat steps 2 through 4 for each group of channels for which you want to set the threshold.

You can exit the threshold setting menu by pressing any other front-panel key.

The threshold voltage setting is used by the input comparators to determine whether an input signal is a logic low or logic high. The settings for each option are shown in table 2.

Table 3

---

**Threshold Voltage Settings**

---

Option	Voltage
TTL	1.50 V
CMOS	2.50 V
ECL	-1.30 V
User	Continuously variable from -6.00 V to +6.00 V

During an *acquisition*, the logic analyzer examines the input voltage at each input probe at a sampling rate defined by the time base setting (Time/Div knob). At each sample, it compares the input voltage to the logic threshold. If the voltage is above the threshold, the analyzer stores a “1” in sample memory; otherwise, it stores a “0.” When sample memory is full, the display logic reconstructs the input waveform from the pattern of bits stored in sample memory. To control the HP 54620A/C acquisition process, you can

- perform continuous acquisitions by pressing the Run/Stop key, and stop them by pressing it again,
- make one acquisition, then stop, by pressing the Single key,
- store the results of several acquisitions by pressing Autostore, or
- erase the results of all acquisitions by pressing Erase.

Chapter 1, “Getting Started,” explains how to use the Run and Stop functions. The others are explained in this section.

## **Auto Glitch Detect**

The HP 54620A/C automatically enables Auto Glitch Detect upon powerup. When the Auto Glitch Detect feature is enabled, it puts the instrument in glitch detect mode at all sweep speeds of 1  $\mu\text{s}/\text{div}$  and slower where the sampling speed must be reduced, thereby preventing aliases from being displayed.

When Auto Glitch Detect is disabled, the HP 54620A/C acquisition system has a record length of 8K samples at all sweep speeds. In addition, you can extend the sweep speed to 2 s/div and 5 s/div in the Main display mode. See “Glitch Detection” in chapter 4.

When Auto Glitch Detect is enabled, a waveform display that contains glitches, separated by the sampling intervals, is an indication that the waveform is being undersampled. A faster Time/Div setting is needed to obtain a correct display of the waveform. This easy indication of undersampling is not available when Auto Glitch Detect is disabled.



## To take a single acquisition

You can detect the presence of aliases in the analyzer's display simply by selecting a faster sweep speed. If the waveform display changes more than expected, it is an alias being caused by undersampling. Whenever a waveform is being displayed as a solid bar, it is highly likely that when you expand the waveform the display will contain aliases.

### Aliasing Produces Misleading Information

Aliasing produces misleading information. The glitch detect circuitry helps prevent aliasing by identifying additional transitions that occur between samples.

Whenever the waveform display is not as expected, it might be an alias—the result of undersampling. Always try to use a sweep speed that produces a sampling interval that is at least 1/2 of the shortest time interval to be acquired.

---

## To take a single acquisition

- Press  .

The analyzer starts the acquisition system and begins searching for the trigger condition.

When the analyzer is in Autostore mode (see “To accumulate the results of every acquisition”) pressing Single adds the results of the new acquisition to the current display contents.

See “To define the trigger mode” in this chapter for more information on how the analyzer's trigger mode affects handling of the trigger condition.

## To use Auto Glitch Detect

- 1 Press Display .

Make sure the **Auto Glitch Detect Enable** softkey is highlighted. The Auto Glitch Detect feature is enabled upon powerup, and puts the logic analyzer in glitch detect mode for all time base speeds slower than 1  $\mu$ s/div.

### Preferred Mode of Operation

The preferred mode of HP 54620A/C operation is Auto Glitch Detect enabled. However, there might be a situation that requires the use of the instrument's full 8K memory to capture the waveform of interest. This can be accomplished by selecting Auto Glitch Detect Disable mode. In this mode you will have no indication that the waveform might be undersampled.

When Auto Glitch Detect is disabled, aliasing can occur, which produces misleading information for data reconstruction. See "Glitch Detection" in chapter 4.

The following display shows no aliasing with Auto Glitch Detect enabled; the waveform appears as expected when expanded.

Figure 11

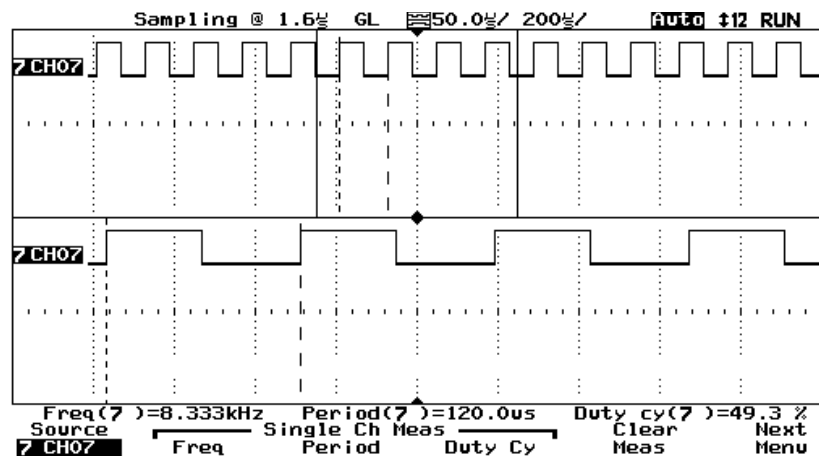

Waveform Display with Auto Glitch Detect Enabled

## To accumulate the results of every acquisition

- Press  .

When Autostore is on, the analyzer updates *pixel memory* (display memory) with new acquisitions, but does not erase the results of previous acquisitions. Instead, for each pixel memory location turned on by a previous acquisition, the analyzer changes the display brightness to half-bright (or to the Autostore color for HP 54620C). Thus, the results of each new acquisition are displayed at full brightness (or to the Autostore color for HP 54620C), and the results of all previous acquisitions are displayed at half brightness.

The indicator “STORE” is displayed at the right end of the status line when Autostore is selected.

When the analyzer is in Autostore mode, pressing  adds the result of the new acquisition to the current display contents.

To turn off Autostore while in Run mode, press  again.

---

## To erase the waveform display

- Press  .

Acquisition memory and the current display are immediately erased. If the instrument is in Run or Autostore mode, however, and the analyzer finds a trigger condition, the display will be quickly updated after the erasure.

---

## Using Labels

The HP 54620A/C allows you to define and assign labels to each input channel. Or, you can turn labels off to increase the waveform display area.

In addition, the HP 54620C allows you to assign colors to channels. This makes it easy to associate input channels with their functions in the system under test.

---

### To turn the label display on or off

- To display channel labels, press  , then press the **Labels** softkey until **On** is highlighted.
- To turn off channel labels display, press  , then press the **Labels** softkey until **Off** is highlighted.
- To toggle the channel labels display, press  repeatedly until the labels are on or off as desired.

The following figure shows the HP 54620C color logic analyzer label menu. You can highlight an individual channel or a set of channels.

## To assign a label to a channel

**1** Press  .

**2** Press the **Define Labels** softkey.

The following figure shows the label maker. A label definition menu is shown on the right-hand side of the display.

**3** Select the channel for which you want to assign a label using the **Select knob**.

You can assign labels to channels that are off and to channels that are on.

**4** Use the **Entry knob** to choose the label you want to assign from the **list of labels**.

The **Entry knob** moves the cursor through the label list, then through the character list. You can also define custom labels. The label list includes all predefined labels, and custom labels you have defined, unless it is re-initialized. See “To define a new label.”

**5** Press the **Copy** softkey.

The selected label is transferred to the entry field.

**6** Press the **Assign Label** softkey.

The label is assigned to the selected channel.

Label display is automatically enabled when you enter the **Define Labels** menu. Thus, if the labels were off, they are turned on while you define labels. If you exit the **Define Labels** menu, and the labels were off before you entered the menu, they are turned off when you exit.

If you defined a new label, it is added to the label list and will be saved with the analyzer configuration.

Figure 12

Scroll through the label and character lists using the Entry knob

The entry field shows you what will be assigned to the channel

Shows what will be put in the entry field when you press Copy

Select the channel with the Select knob

Sampling @ 4.00µs      f 0.00s 500µ/      f0 RUN

0	CH00	Ack	Cont	L	Read
		Addr0	D0	Latch	Ready
		BHE_	D11	Load	Recv
		BLE_	DS_	NMI	Reset
1	CH01	CAS_	DT/R_	OE	STB
		_N	CE	Data0	Out
		_P	CH05	Otack	Pin_
2	CH02	/Q0	CLK	EN	Q0
		1MHz	CNT	Enable	Q_
		1kHz	CP	GL RQ	R/W_
3	CH03	AO	CS_	Halt	RAS_
		AD0	CTL	IO	RD
		ADS_	Clear	IRQ	RDY
7	CH07	ALE	Clk	In	REQ
		AS_	Clr	Int	RST
8	CH08				Xmit
9	CH09				

ABCDEF GHIJ KLMNOPQRSTU VWXYZ  
0123456789 !#/:<>[\]\*+,-\_`~  
abcdefghijklmnopqrstuvwxyz

Copy Shift → [ ] → Assign to 2

'Entry' Knob selects from both Label List and Characters List

Delete Character	Insert Space	Copy	Position	Assign Label	Previous Menu
Press to delete the character at the cursor in the entry field	Press to insert a space in the entry field at the cursor	Press to copy the selected label/character to the entry field	Press to move the cursor through the entry field	Press to assign the label to the channel	

HP 54620A/C Label Definition Display

## To define a new label

1 Press  .

2 Press the **Define Labels** softkey.

A label definition menu is shown on the right-hand side of the display.

3 To use an existing label as the basis for the new label, use the **Entry** knob to choose a label from the list of labels. Then press the **Copy** softkey.

The **Entry** knob moves the cursor through the label list, then through the character list. The label list includes all predefined labels, and custom labels you have defined, unless it is re-initialized. When you press the **Copy** softkey, the selected label is transferred to the entry field.

4 To enter characters into the new label:

a Press the **Position** softkey until the cursor position in the entry field corresponds to the point where you want to replace a character.

b Enter or delete a character.

- To enter a character, use the **Entry Knob** to choose a character from the character list. Then press the **Copy** softkey.
- To insert a space, press the **Insert Space** softkey.
- To delete the current character, press the **Delete Character** softkey.

**Delete Character** deletes the character under the cursor and moves successive characters forward by one position.

5 Press the **Assign Label** softkey.

The label is assigned to the selected channel.

Label display is automatically enabled when you enter the **Define Labels** menu. Thus, if the labels were off, they are turned on while you define labels. If you exit the **Define Labels** menu, and the labels were off before you entered the menu, they are turned off when you exit.

### **Label Assignment Auto-Increment Features**

When you assign a label ending in a digit, such as ADDR0 or DATA0, the analyzer automatically increments the digit and displays the modified label in the entry field. Then, the analyzer changes the selected channel to the next channel down on the display that is on. This makes it easier to assign successive labels to numbered control lines and data bus lines.

### **Label List Management**

The label list contains 75 of the most recently used labels. The list does not save duplicate labels, nor does it save multiple labels that differ by, at most, two trailing numeric characters.

The label list is non-volatile. Thus, after you use the label list for awhile, your labels will predominate, making it easier to customize the analyzer display for your needs.

When you first begin using the analyzer, there are seven blank entries at the beginning of the label list. As you define custom labels, these spaces are filled. One blank space is always retained to allow entry of a new label. When you initialize the label list, all of your custom labels will be cleared, and the label list will be returned to its factory configuration.



## To initialize the label list

1 Press  .

2 Press the **Initialize Label List** softkey.

A message appears, warning you that this operation will overwrite the current label list.

- To confirm the operation, press the **Yes** softkey. You will be prompted to press Yes again to initiate the operation.
- To cancel the operation, press the **No** softkey.

When you first begin using the analyzer, there are seven blank entries at the beginning of the label list. As you define custom labels, these spaces are filled. One blank space is always retained to allow entry of a new label. When you initialize the label list, all of your custom labels will be cleared.

---

# Triggering the Analyzer

The HP 54620A/C allows you to synchronize the analyzer display to the actions of the circuit under test by defining a trigger condition. The analyzer offers three types of triggering, allowing you to match the complexity of the trigger to that of the data you want to capture.

---

## Trigger types

These trigger types are as follows:

- Edge trigger
- Pattern trigger
- Advanced trigger

Changes to the current trigger specification are handled in real-time. If the analyzer is stopped when you change a trigger specification, it uses the new specification as soon as you press `Run/Stop`, `Single`, or `Autostore`. If the analyzer is in Run mode when you change a triggering specification, it immediately begins a new acquisition using the new trigger definition.

### Edge Trigger

In *edge trigger*, you define a single rising or falling edge (or either) that must be recognized on an input channel to satisfy the trigger condition.

Edge trigger is best when there is a unique waveform edge that defines the events you wish to capture. For example, a gate signal that defines the beginning of a pulse train on another channel will often make a good edge trigger. Edge trigger is less useful when the set of events that occur after the edge change dramatically after every edge, or when the edges occur very frequently in relation to other signals.

### **Pattern Trigger**

In *pattern trigger*, you define a pattern of highs, lows, and don't care inputs that must be recognized across the input channels during any given input sample. The pattern may be combined with one edge on any input channel to form the complete trigger specification.

Pattern trigger is best when there is a unique pattern that occurs across a group of signals, and the pattern defines the events you want to capture. For example, suppose you have a state machine that outputs a series of hex digits, and only outputs the digit 'A' once in every sequence. You can use a pattern trigger to capture this event.

Pattern trigger is less useful when the same pattern occurs many times, and most of those occurrences have little to do with the events you wish to capture. For example, suppose that this same state machine generates hundreds of states, and the state "C" occurs several times in the sequence, with a different sequence of states after each occurrence. A pattern trigger will not provide a stable waveform display.

The pattern trigger occurs when the pattern is entered; that is, the trigger condition is satisfied as soon as the input waveforms have transitioned from a state not matching the pattern to a state matching the pattern. You can use the single edge to further qualify the trigger condition. For example, you may want the analyzer to trigger when a certain pattern is present and a clock edge occurs.

Figure 13

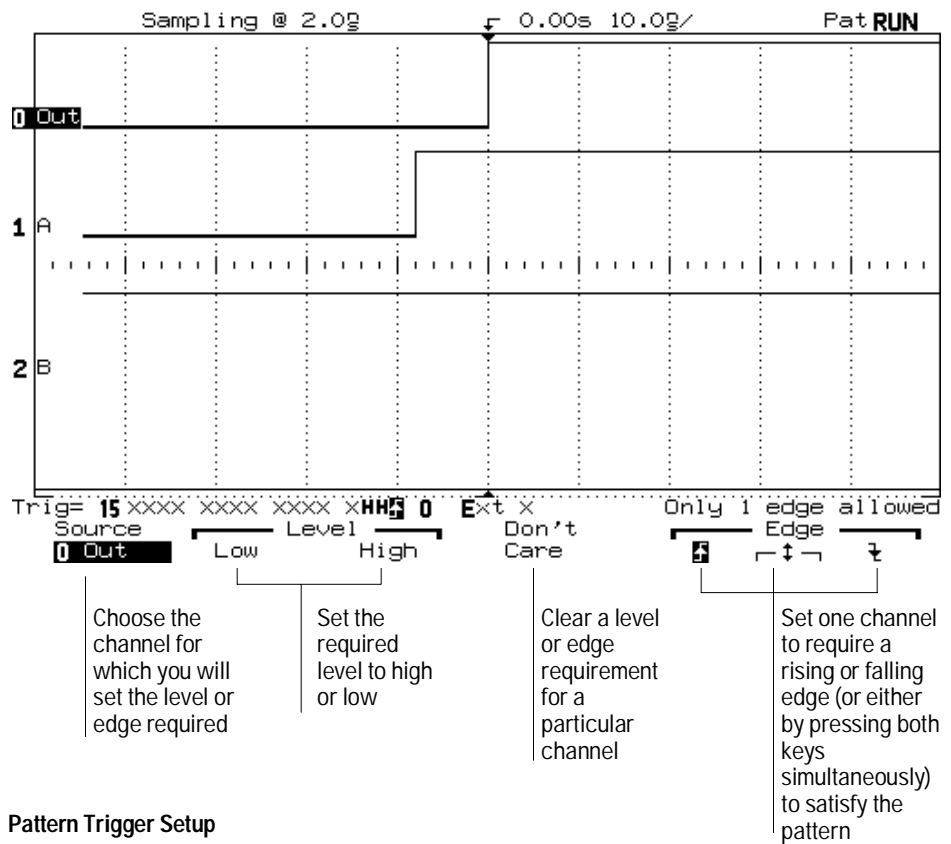

**Pattern Trigger Setup**

**Advanced Trigger**

In *advanced trigger*, you define up to two pattern and edge sources that are combined with a variety of operators to form the complete trigger specification.

Advanced trigger is best when the events you want to capture are defined by a complex series of waveform events in the system, and neither pattern mode nor edge mode are capable of clearly resolving the necessary sequence. For example, suppose the events you want to capture are defined by the *n*th occurrence of an edge, by a pattern with a certain minimum duration, or by a pattern followed by another pattern. Advanced trigger gives you this and more.

Figure 14 shows an advanced trigger setup, with the overview display turned on. The display shows a pattern duration trigger.

Figure 14

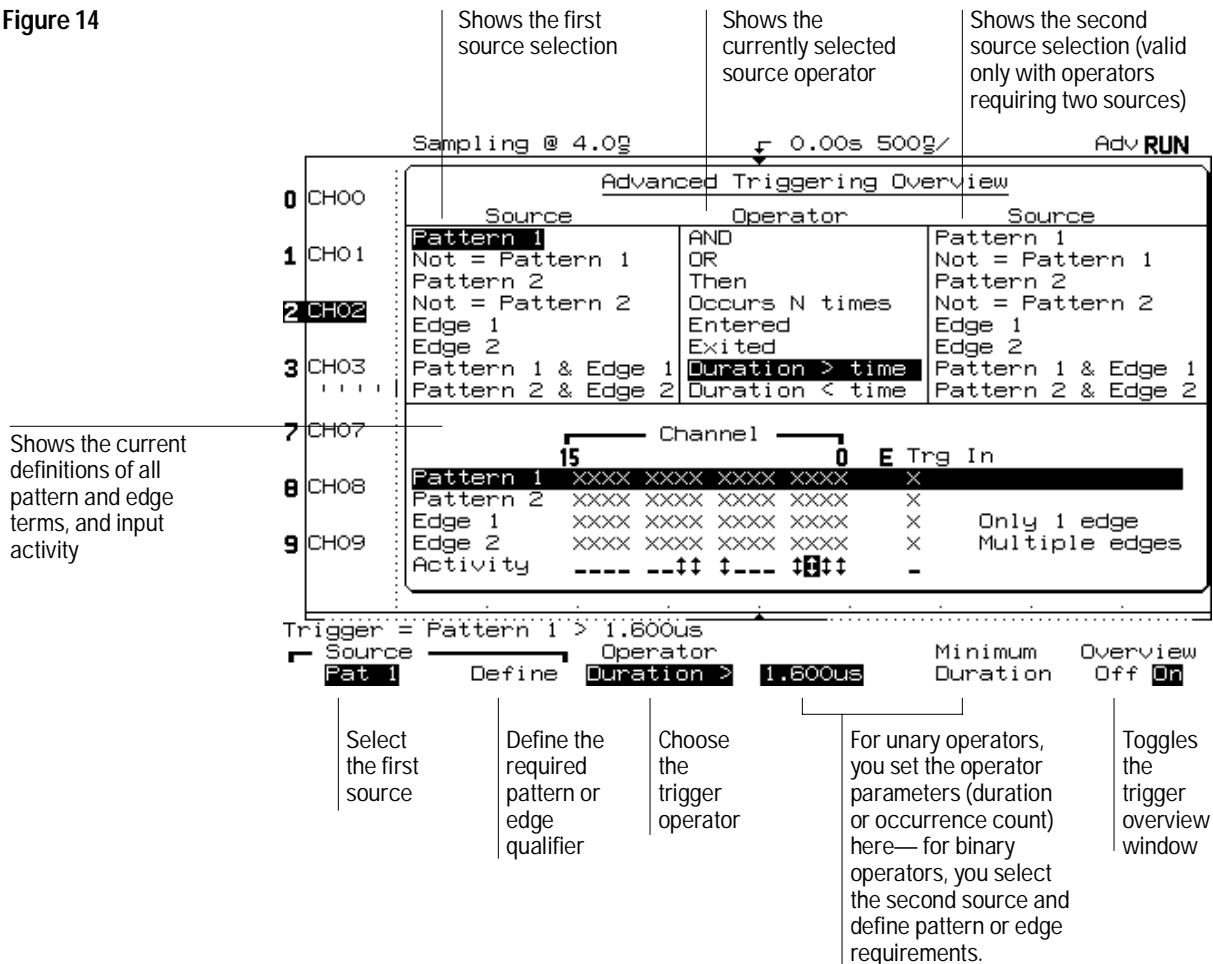

Advanced Trigger Setup (with Overview On)

Figure 15

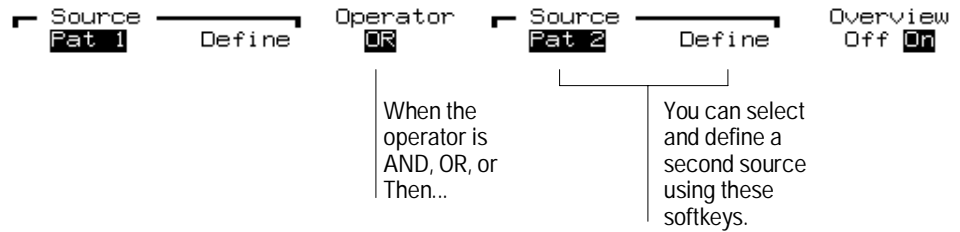

### Advanced Trigger Softkeys for Operators with Two Sources

#### Sharing of Sources

The source definitions for the simple pattern trigger are shared with the Pattern 1 and Edge 1 sources of the advanced trigger specification. Thus, changes to the simple pattern trigger will affect that specification, and changes to Pattern 1 and Edge 1 in the advanced trigger specification will affect the simple pattern trigger. Defining patterns for the two trigger types differs. See “To define a pattern trigger” and “To define an advanced trigger.”

#### Logical Combination within Terms

In the pattern trigger, all settings within the pattern are logically ANDed; that is, all conditions on the pattern, and the edge if specified, must be satisfied before the analyzer will trigger.

In the advanced trigger, settings within pattern terms are logically ANDed. Settings within edge terms are logically ORed. This is only important for the Edge 2 term, where you can define different edge specifications for each channel. Thus, only one of those edge specifications must be satisfied to satisfy the edge term.

---

## To define the trigger mode

- 1 Press `Mode` .
- 2 Select the mode using the **Trigger Mode** softkeys.  
You can select either Normal mode or Auto mode.

### Trigger Mode

The trigger mode affects the way in which the analyzer searches for the trigger. Figure 16 shows the conceptual representation of acquisition memory. You can think of the trigger event as dividing acquisition memory into a pre-trigger and post-trigger buffer. The position of the trigger event in acquisition memory is defined by the time reference point and the delay setting.

Figure 16

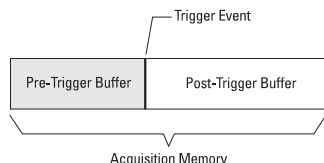

### Acquisition Memory

**Normal mode** In Normal trigger mode, the analyzer has the same behavior whether the acquisition was initiated by pressing Run/Stop or Single. The analyzer begins filling the pre-trigger buffer with data. As soon as that buffer is full, the analyzer will begin searching for the trigger event, and will flash the trigger condition indicator on the status line to indicate it is doing so. While searching for the trigger, the analyzer overflows the pre-trigger buffer, with the first data put into the buffer being the first pushed out (FIFO).

When the trigger event is found, the analyzer will fill the post-trigger buffer and display the acquisition memory. If the acquisition was initiated by `Run/Stop` , the process repeats.

**Auto mode** The analyzer fills the pre-trigger buffer, then searches for the trigger event for a predetermined interval. This interval is a function of the Time/Div setting, but is never less than 40 ms. If no trigger is found, the analyzer forces a trigger and displays the data as though a trigger had occurred.

The subsequent behavior depends on whether the acquisition was initiated by pressing Single or Run:

- Single—the analyzer will fill acquisition memory, stop, and display the results.
- Run—the analyzer will fill the pre-trigger buffer after drawing a trace. When the pre-trigger buffer is full, the analyzer repeats the search for a trigger. If no trigger is found, a free-running trace is displayed, much like that of an oscilloscope on auto trigger.

In either Auto or Normal mode, the trigger may be missed completely under certain conditions. This is because the analyzer will not recognize a trigger event until the pre-trigger buffer is full. Suppose you set the Time/Div knob to a slow sweep speed, such as 500 ms/div. If the trigger condition always occurs before the analyzer has filled the pre-trigger buffer, the trigger will not be found.

Some measurements you want to make will require you to take some action in the circuit under test to cause the trigger event. Usually, these are single-shot acquisitions, where you will use the Single key. If you use Normal mode and wait for the trigger condition indicator to flash before causing the action in the circuit, the analyzer will always find the trigger condition correctly.

See chapter 4, “Ensuring Accurate Measurements,” for more information on the acquisition process and the relationships between time base and sampling rate.

#### **Trigger Mode versus Trigger Type**

The trigger mode (Auto or Normal) is independent of the trigger type (Edge, Pattern, or Advanced). The mode setting applies for any trigger type.



## To define an edge trigger

- 1 Press Edge .
- 2 Do one of the following:
  - Press the **Trg In** softkey under **Source** to choose the External Trigger input as the trigger source.or
  - Select a channel as the trigger source using the Select knob, the Entry knob, or the softkey.  
You can choose a channel that is turned off as the source for the edge trigger.
- 3 Press one of the **Edge** softkeys to choose whether the trigger will occur on the rising edge, falling edge, or both edges of the input signal.

### Rotating Select Knob does not Affect Trigger Channel

Continuously rotating the Select knob will not affect the channel used for the trigger condition, after the **Edge** softkey has been pressed to set the condition.

---

## To define a pattern trigger

- 1 Press Pattern .
- 2 Do the following for each channel in the desired pattern (including the external trigger input):
  - a Select a channel for the external trigger input either by pressing the **Source** softkey, or by rotating the Select knob or Entry knob.
  - b Press a softkey to set the condition the analyzer will recognize as part of the pattern for that channel:
    - **Low** for a logic low.
    - **High** for a logic high.
    - **Don't Care** to ignore this channel.
    - Rising, falling, or both edges.

Only one edge term is allowed in the pattern. If you define an edge term, then select a different channel in the pattern and define another edge term, the previous edge definition is changed to a don't care.

### Source Definitions for Simple Pattern Trigger Affect Advanced Trigger

The source definitions for the simple pattern trigger are shared with the Pattern 1 and Edge 1 source definitions of the advanced trigger specification. Thus, changes to the simple pattern trigger will affect that specification, and changes to Pattern 1 and Edge 1 in the advanced trigger specification will affect the regular pattern trigger. However, defining patterns for an advanced trigger is different. See "To define an advanced trigger."

## To define an advanced trigger

- 1 Press **Adv**.
- 2 Press the **Overview** softkey to turn on the trigger overview, if desired.  
The trigger overview display simplifies the trigger setup by allowing you to see the current source and operator selections and source definitions (pattern and edge definitions).
- 3 Choose the trigger operator by pressing the **Operator** softkey until the desired operator is shown.  
Table 3 lists the trigger operators and the sources with which they can be used. Notice that the sources specified (in step 5) can limit your choice of trigger operators, and your choice of trigger operators can limit which sources are available.
- 4 Set the parameters for the trigger operator, if necessary.  
For the Duration > and Duration < operators, press the duration value softkey or turn the Entry knob to set the duration. You can set the minimum duration available by pressing the **Minimum Duration** softkey.  
For the Occurrence operator, press the **Occurrence** softkey or turn the Entry knob to set the number of occurrences. You can reset the number of occurrences to 1 by pressing the **Minimum Occurrence** softkey.
- 5 Choose the source(s) for the trigger operator by pressing the leftmost softkey under each “Source” heading until the desired source is highlighted.  
Table 3 lists the sources and the operators with which they can be used. Note that the analyzer will allow you to choose combinations of sources that are redundant, such as “Pat\_1 AND Pat\_1,” or that will create a null trigger condition, such as “Pat\_1 AND Not = Pat\_1.”
- 6 Set up the source(s) by pressing the **Define** softkey under the “Source” heading for the desired source.  
If you have combined patterns and edges in the same source term, you will need to separately select each as the source (step 5), set up the source (step 6), then re-select the combined pattern and edge.  
To set up an edge source:
  - a Select a channel using the **Select** knob or the **Entry** knob.
    - To choose whether the trigger will occur on the rising edge, falling edge, or both edges of the input signal, press one of the **Edge** softkeys.

- To set a channel to don't care (not part of the trigger specification), press the **Don't Care** softkey.
  - To clear all edge settings, press the **Clear Edge(s)** softkey.  
In Edge1, only one edge can be selected. Multiple edges may be selected in Edge2; they are logically ORed.
- b** Repeat step a for all channels you want to change.
- c** Press **Previous Menu** to return to the Advanced Trigger menu.

To set up a pattern source:

- a** Select a channel using the **Select knob** or the **Entry knob**.
- To set the condition for that channel, press one of the **Low**, **High**, or **Don't Care** softkeys.
  - To clear the condition settings for all channels, press the **Clear Pattern** softkey.
- b** Repeat step a for all channels you want to change.
- c** Press **Previous Menu** to return to the Advanced Trigger menu.

Table 4

Trigger Operators and Sources

Operator	# of Sources	Valid Sources
Duration	One	Pat_1, Not = Pat_1, Pat_2, Not = Pat_2
Occurs	One	Edge1, Edge2, Pat_1 AND Edge1, Pat_2 AND Edge2
Entered, Exited	One	Pat_1, Not = Pat_1, Pat_2, Not = Pat_2
AND, OR, Then	Two	Pat_1, Not = Pat_1, Pat_2, Not = Pat_2, Edge1, Edge2, Pat_1 AND Edge1, Pat_2 AND Edge2

In the table, *entered* means that the trigger qualifier is satisfied as soon as the input waveforms have transitioned from a state not matching the pattern to a state matching that pattern. *Exited* means that the trigger qualifier is satisfied when the input waveforms transition out of a state matching the pattern to a state not matching the pattern.

Advanced trigger can help you solve difficult data acquisition problems. There are two things to remember when setting up an advanced trigger: first, follow the setup rules; second, have a clear picture of the event sequence you

are trying to capture and understand how the advanced trigger capabilities relate to those events.

### Setup rules

Remembering the following rules will make it easier to work with the advanced triggering capabilities:

- Duration operators are valid when only pattern terms are involved. Duration is *not* selectable when any edge terms are selected as a source. Occurrence operators are valid only when at least one edge term is involved. Occurrence is *not* selectable when only pattern terms are selected as a source.
- When you have selected a combination source, like Pat\_1 AND Edge1, you cannot directly define the pattern or edge. You must instead select Pat\_1 as the source, define the pattern, then select Edge1 as the source and define the edge. The softkeys change to reflect this.

### Understand the waveform events and relate them to analyzer capabilities

The key to setting up a useful waveform display is picking a known sequence of waveform events to which you can apply the advanced trigger capabilities of the HP 54620A/C.

To find these events, you can ask a series of questions about the waveform, keeping in mind the capabilities of the analyzer.

- Does the input data always repeat with respect to a particular waveform's high or low period of constant duration?
- Is there a sequence of waveform events that define the data of interest? For example, is there a state machine, where the hypothetical sequence "aac" leads to the events of interest, where "aab" does not?
- Are the events of interest defined by a certain number of iterations of a circuit? For example, does the circuit fail (producing the events of interest) on the 38th iteration of a data pattern and edge combination?

Usually, you will want to set the analyzer to Normal trigger mode so that you see a display only when the trigger condition occurs. However, you might want to use Auto trigger mode while experimenting with the trigger definition so you can see a display of the data that is captured by the analyzer.

**Example**

Suppose you have a pulse train where one of the pulses is of constant duration ( $4\ \mu\text{s}$ ) and all other signals of interest are repeated with that pulse train. See figure 17.

**Figure 17**

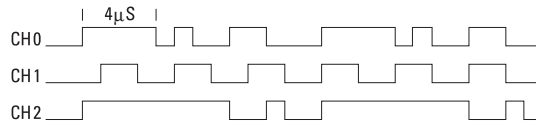

**Pulse Train with Constant-Duration Pulse**

To trigger the analyzer on that pulse, you can use the trigger setup in the following table:

Source	Operator and Parameters	Pattern/Edge
Pattern 1	Duration > $3.9\ \mu\text{s}$	H on channel 0, others don't care

**Example**

Suppose you have a state machine whose three outputs, Q0 through Q2, output the decimal sequence 0-1-6-0-6-1-0-1-6-0-6-1. Q2 is the most significant bit. See figure 18.

**Figure 18**

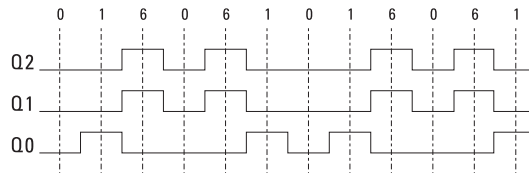

**Sequential Output from State Machine**

If you try to trigger on any of the single output patterns 0, 1, or 6, the display will not be stable. However, you can use the “Then” operator to trigger on the sequence of pattern “0” followed by pattern “1.” If Q2, Q1, and Q0 are connected to channels 2, 1, and 0 respectively, you can use the setup in the following table to trigger the analyzer.

To define an advanced trigger

Source	Operator and Parameters	Pattern/Edge
Pattern 1	Then	L on channels 2, 1, and 0, others don't care
Pattern 2	N/A	L on channels 2 and 1, H on channel 0, others don't care

**Example**

Suppose you have a microcontroller-based system that consistently fails the third time you push a particular front-panel switch when a particular system display menu is active. If M1 and M0 represent the particular data lines that indicate menu state, and the system menu in question is active when both these lines are high, then figure 19 represents a combination of events leading to the failure condition.

**Figure 19**

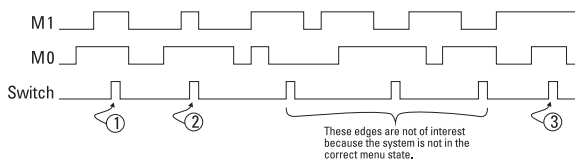

**System Failure on Third Keystroke**

If input lines M1, M0, and SWITCH are connected to input channels 2, 1, and 0 respectively, the following trigger configuration will trigger the analyzer when the failure condition occurs. The occurrence count is incremented each time the edge occurs when the associated pattern is true.

Source	Operator and Parameters	Pattern/Edge
Pattern 1 & Edge 1	Occurs 3 times	H on channels 2, 1 in Pattern 1; Rising Edge on channel 0 in Edge 1

### **All Qualifiers must be Satisfied to Trigger the Analyzer**

When setting up an advanced trigger, you must remember that all required events must be satisfied to trigger the analyzer. For example, if you set up an occurrence trigger using Pattern 1 and Edge 1, and the occurrence count is 3, then Edge 1 must be satisfied three times, with the pattern valid each time, before the trigger will occur.

### **Pattern 1 and Edge 1 are Shared Sources**

The source definitions for Pattern 1 and Edge 1 are shared with the pattern trigger specification. Thus, changes here will affect that specification, and changes to the simple pattern trigger specification will affect the definitions of Pattern 1 and Edge 1. Defining patterns for a pattern trigger is different. See "To define a pattern trigger."



---

## Examining the Captured Data

The HP 54620A/C has features to make viewing acquired data easier. These include delayed sweep, the graticule, and printing.

---

### Viewing acquired data with delayed sweep

Delayed sweep is an analyzer display function that magnifies the contents of sample memory. Using the delayed sweep, you can zoom in on a portion of the waveform and examine it in greater detail. Figure 20 shows a display with delayed sweep.

Because delayed sweep magnifies the contents of sample memory, the data used by both main and delayed sweep windows was acquired on a single acquisition—and, they both correspond to the same trigger event.

Using the delay setting, you can pan through the waveform in either main or delayed mode.

Figure 20

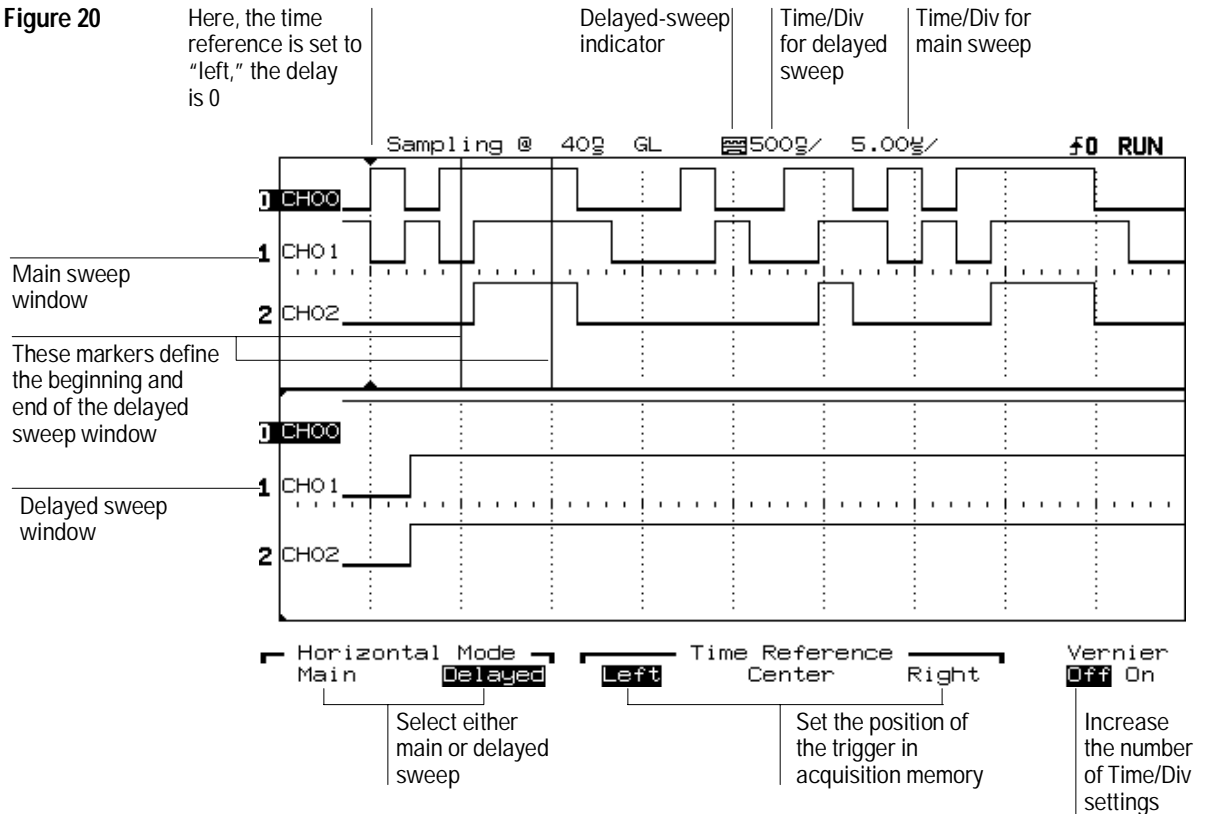

### Delayed Sweep

### Graticule

The graticule on the HP 54620A/C has three settings, Full, None, and Frame, allowing you to change the pattern of hash marks on the display. This can make it easier to view or measure waveform events.

### Printing

You can print the status line and the waveform display to an HP- or Epson-compatible printer attached to one of the optional interface modules (HP 54650A—HP-IB, or HP 54651A or HP 54652A/B—RS-232). These printouts can be used for analysis, publication, test reports, and so on.

## To show both main and delayed sweep displays

1 Press  .

2 Press the **DeLayed** softkey.

The display is divided into a main and delayed sweep. The delayed sweep is shown in the bottom half and represents the portion of the waveform indicated by the vertical lines outlining a window in the upper half.

The Time/Div setting for the delayed sweep is independent of the main sweep, except that it can be no slower than twice the speed of the main sweep. It is adjusted using the Time/Div knob. Figure 20 shows the Time/Div indicator for the delayed sweep. If you need to change the Time/Div for the main sweep, you must change back to Main before using the Time/Div knob.

---

## To change the time reference position

1 Press Main/Delayed .

2 Choose the time reference position from the **Time Reference** softkeys:

- To set the time reference so that most of the acquired data follows the trigger, press the **Left** softkey.

The time reference indicator will be one division in from the left side of the display. The trigger event will be at the same location unless the delay is set to a value other than 0.

- To set the time reference so that the acquired data is centered around the trigger, press the **Center** softkey.

The time reference indicator will be at the middle of the display. The trigger event will be at the same location unless the delay is set to a value other than 0.

- To set the time reference so that most of the acquired data precedes the trigger, press the **Right** softkey.

The time reference indicator will be one division in from the right side of the display. The trigger event will be at the same location unless the delay is set to a value other than 0.

The time reference position sets the initial position of the trigger event within acquisition memory and on the display, with delay set to 0. The delay setting sets the specific location of the trigger event with respect to the time reference position. The time reference setting affects the delayed sweep as described in the following ways.

The point about which the delayed sweep is expanded changes (as Time/Div is varied):

- For a time reference setting of **Left**, the sweep expands from the left-hand side of the display.
- For a time reference setting of **Center**, the sweep expands about the center of the display.
- For a time reference setting of **Right**, the sweep expands from the right-hand side of the display.

## Making Analyzer Measurements To change the time reference position

The delay time reference point changes:

- For a time reference setting of Left, the delay time is measured from the trigger to the left-hand edge of the delay window (the marker location).
- For a time reference setting of Center, the delay time is measured from the trigger to the center edge of the delay window.
- For a time reference setting of Right, the delay time is measured from the trigger to the right-hand edge of the delay window.

Figure 21 shows the time reference position set to Center, with horizontal mode set to Main and a delay setting of 15  $\mu\text{s}$ . Thus, the trigger position is just slightly before the middle of acquisition memory.

Figure 21

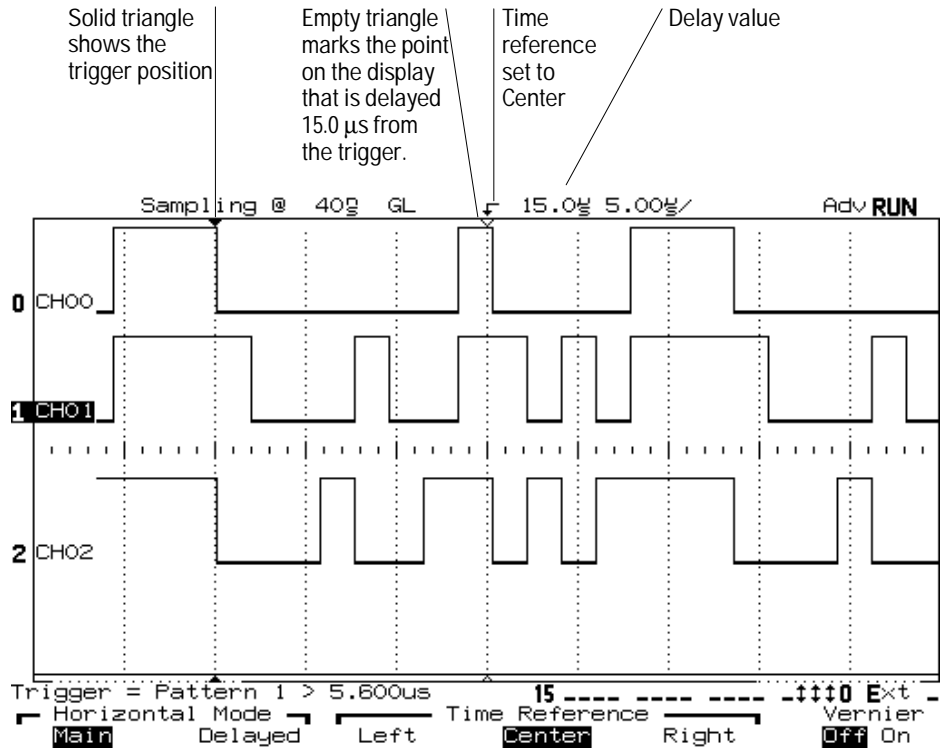

Time Reference at Center, Delay of 15  $\mu\text{s}$  on Main Sweep

Figure 22 shows the same acquisition with the horizontal mode set to Delayed. Again, the time reference is set to Center. Though the marker (the solid triangle ▼) points to the trigger event in both the main and delayed sweep, the delay values themselves are independently adjustable. The delay value for the delayed sweep is set to 8  $\mu$ s. This is different than the setting for the main sweep, which remains at 15  $\mu$ s in this figure, and is not adjustable with the delay knob (while the delayed sweep is active). In both the main and delayed sweep, the hollowed triangle (▽) indicates the part of the waveform that is delayed by the respective value from the trigger event.

**Figure 22**

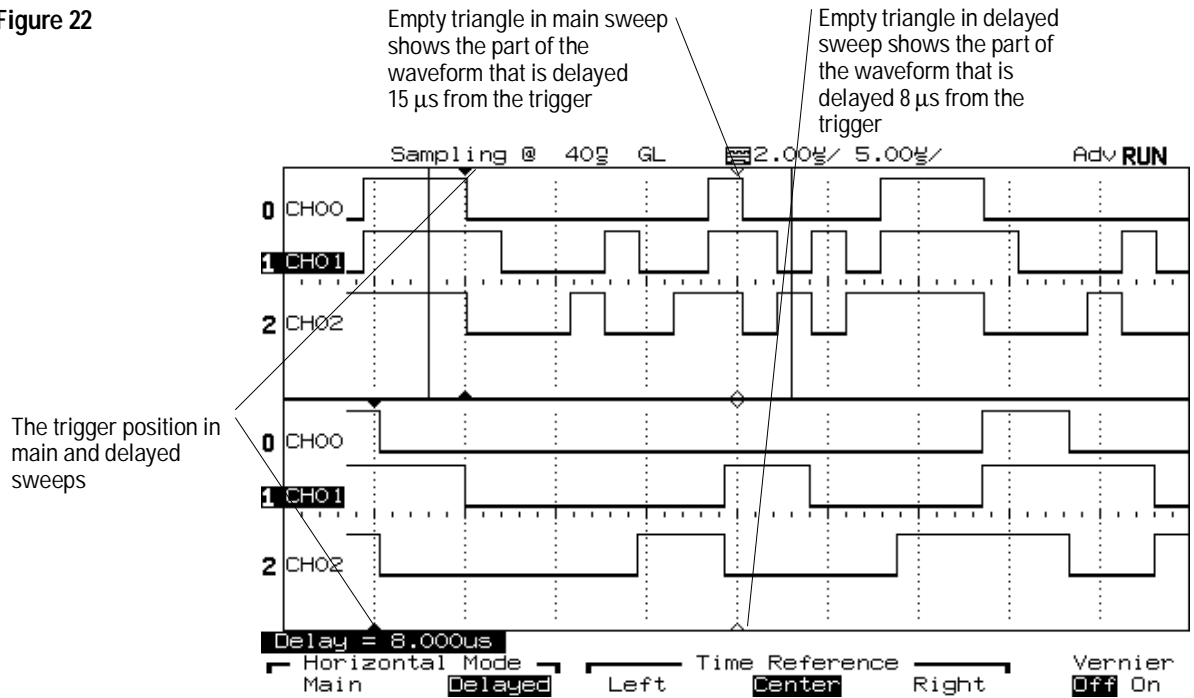

**Delayed Sweep with Delay of 8  $\mu$ s**

## To pan the display

- **Turn the Delay knob.**

The Delay knob adjusts the amount of time between the trigger event and the time reference point on the display. When the delay value is positive, the time reference point represents the end of the delay time; when it is negative, the time reference point represents the beginning of the delay time.

Subsequent acquisitions are adjusted to capture sufficient data to fill the Main display; the delayed window is limited to that data available in the Main display.

See “To change the time reference position” in this chapter. Also see “Time base and Acquisition” in chapter 4 for more information about the function of the Delay knob.

---

## To modify the graticule

- 1 Press  .
- 2 Press one of the **Grid** softkeys to define the graticule used for the waveform area on the display.
  - **Full** has a set of hash marks through the center of the waveform display area, with major divisions indicated by a full-height dotted line through the waveform display.
  - **None** has only a border around the waveform display area.
  - **Frame** has a set of hash marks along the top and bottom of the display only. Major divisions are indicated by longer hash marks.

Each major division in the graticule corresponds to the time given by the Time/Div setting, shown to the right of the delay value on the display.



## To print the display

- 1 Press `Print/Utility`.
- 2 Press **Print Screen**.

The current display is copied to the attached printer. You can stop printing by pressing the **Cancel Print** softkey.

See the documentation for the interface module for information on installing and configuring module interface parameters.

---

# Measuring Waveform Data

The HP 54620A/C has three features for measuring waveform parameters:

- Cursors
- Single-channel measurements
- Dual-channel measurements

---

## Ways to measure data

### **Cursors**

The cursors provide a manual way to measure either time between particular points on the display (usually associated with waveform events) or the numeric value of the currently displayed waveforms. Two cursors, t1 and t2, are available. You position these cursors with the Entry knob and read the results, in time or value, from the measurement field.

Ways to measure data

Figure 23 shows the cursors used to measure the period of an irregular waveform on channel 4; the period can be read from the  $\Delta t$  display in the measurement field as 28.50  $\mu s$ .

Figure 23

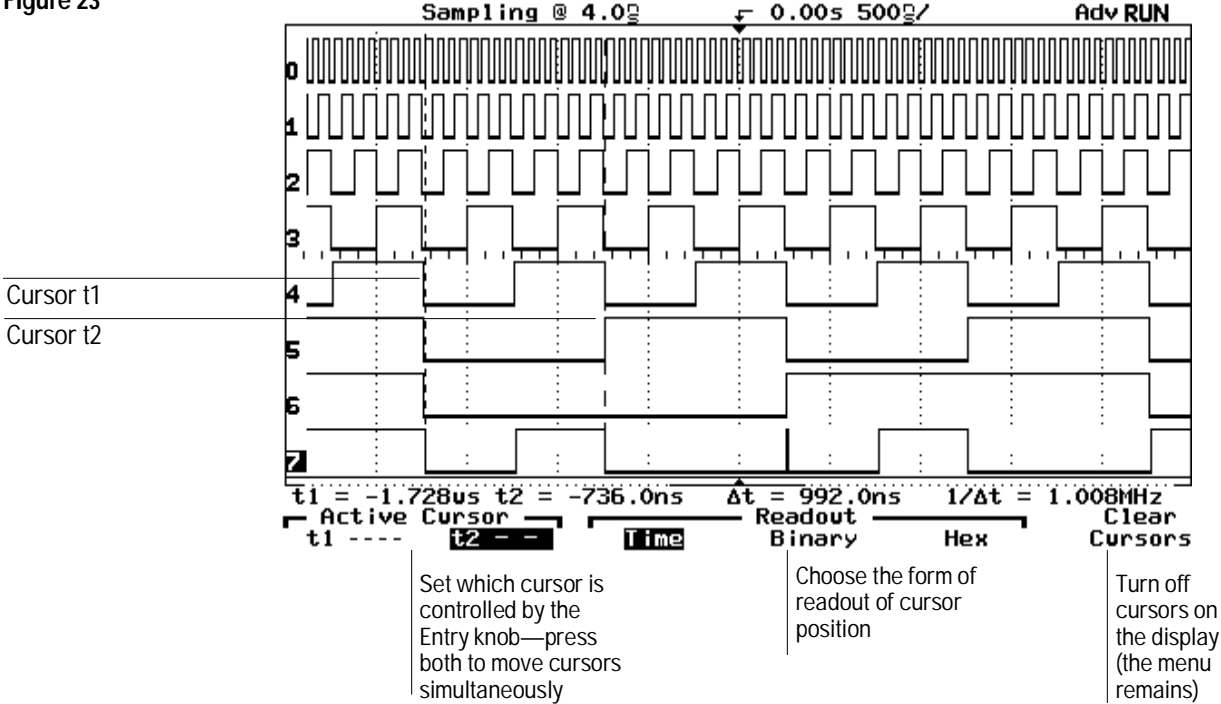

Measuring the Period of an Irregular Waveform

### Single-Channel Measurements

All five of the single-channel measurements in the HP 54620A/C—period, frequency, duty cycle, positive width, and negative width—are concerned with measuring the time between sets of events on the same channel, then calculating the appropriate values based on the definition of the measurement.

Figure 24 shows frequency, period, and duty-cycle measurements on channel 3 of the input.

Figure 24

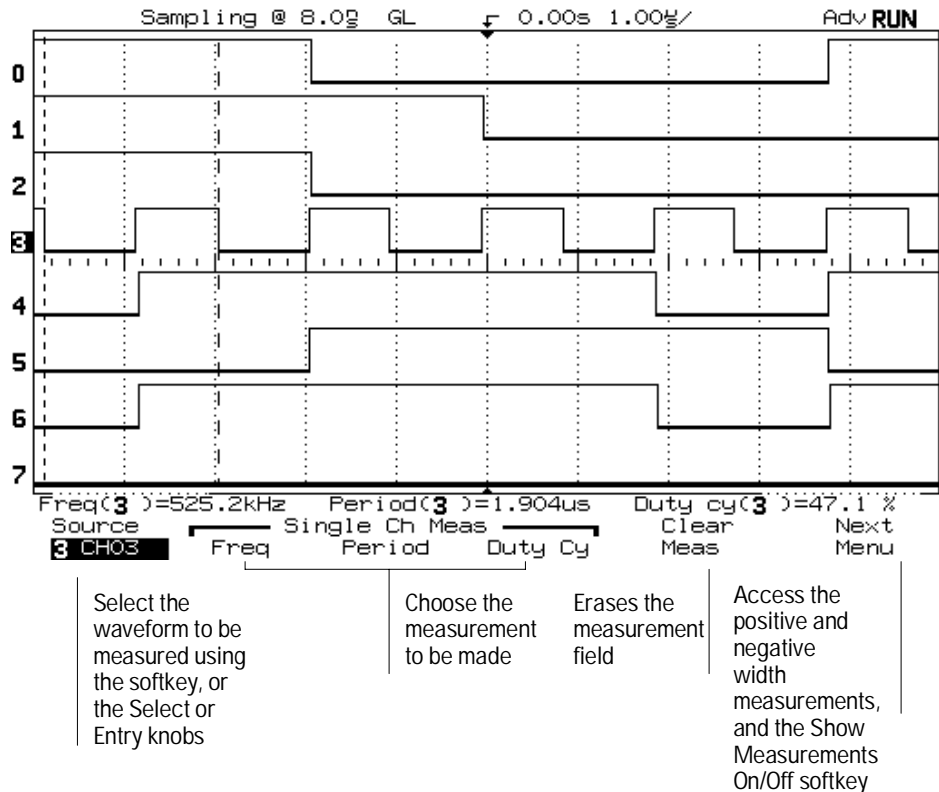

### Single-Channel Measurements

**Dual-Channel Measurements**

All three of the dual-channel measurements in the HP 54620A/C—channel-to-channel delay, setup time, and hold time—are concerned with measuring the time between edges on two different channels.

Figure 25 shows a channel-to-channel delay measurement. Other dual-channel measurements have similar softkey menus.

**Figure 25**

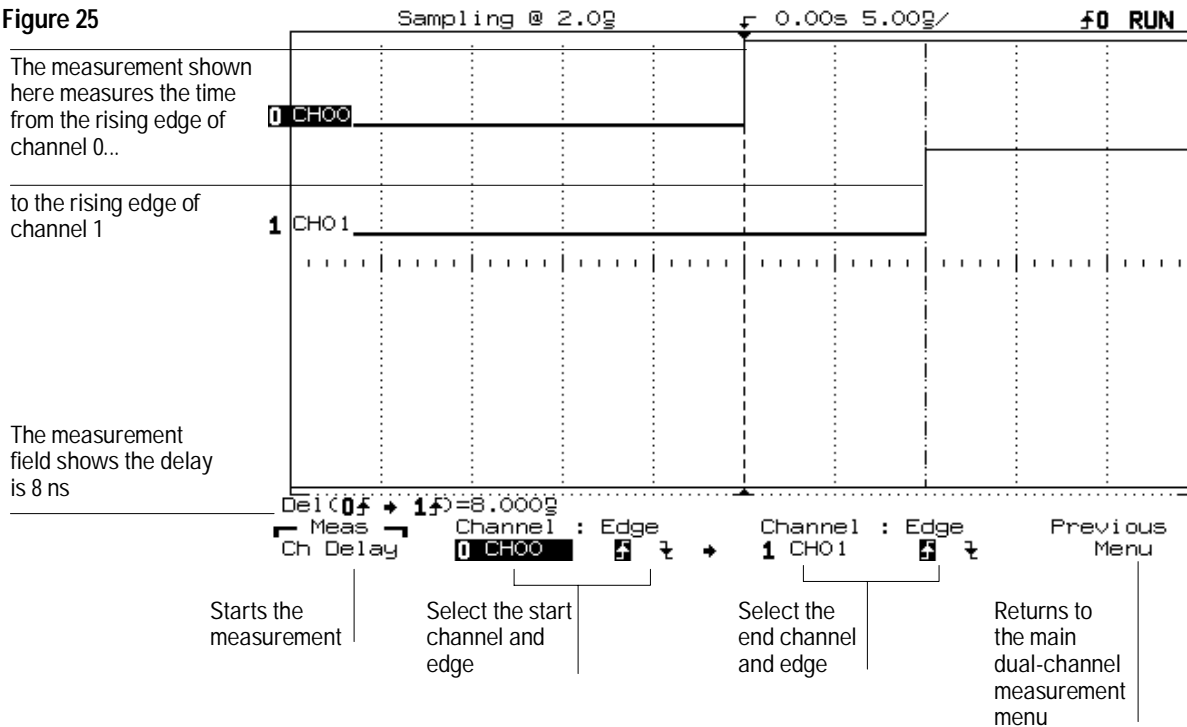

**Channel-to-Channel Delay Measurement**

**Measurement Process**

To make a measurement, the analyzer searches across the displayed waveform from the left side of the screen to the right until it finds a set of edges that can be used to make the measurement. Thus, you can only measure things that are displayed (except that Autostore data cannot be measured). Parts of the waveform not on screen cannot be measured.

A glitch is counted as having a rising and a falling edge, so if a glitch appears as the first set of edges on screen, it will be treated as part of the waveform for single-channel measurements. For dual-channel measurements, the glitch will be used as a representative edge for either channel in the channel-to-channel delay measurement, and for the data channel in either the setup or hold measurements. It will not be used for a clock edge in the setup or hold measurements. The measurement field will show either “>” or “<” instead of “=” if a glitch was used to calculate the results.

In Delayed mode, if the analyzer can find a set of edges within the delayed sweep window that will satisfy the measurement criteria, then those edges are used for the measurement. Otherwise, edges both inside and outside the window are used to make the measurement. Thus, you can use delayed sweep to window a specific part of the display where you want to make a measurement. To include the desired edges, adjust the delay (Delay knob) and sweep speed (Time/Div) knob for the delayed sweep. See the following figure.

Figure 26

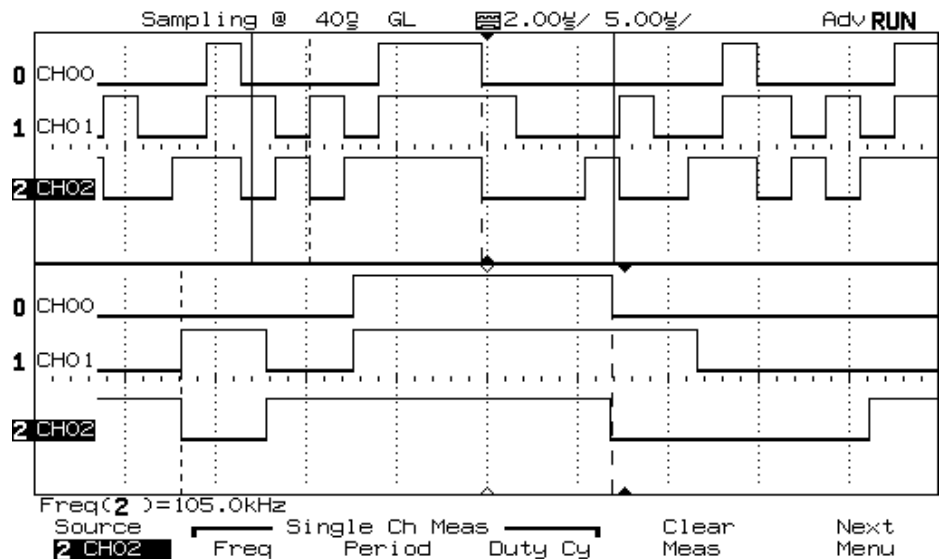

Measurement Within the Delayed Sweep Window

## To use the cursors

- 1 Press **Cursors** .
- 2 Push the **t1** or **t2** softkey to choose which cursor is active.  
Either t1 or t2 is always active when the cursors are on. To move both cursors simultaneously, press both the t1 and t2 softkeys simultaneously.
- 3 Set the position of the active cursor using the **Entry** knob.
- 4 Select the type of readout by pressing **Time**, **Binary**, or **Hex**.

The cursors allow you to make measurements on waveforms when a standard single- or dual-channel measurement will not achieve the desired results. You can position the t1 and t2 cursors anywhere on the visible display and see the time from trigger,  $\Delta t$  between the cursors, and the frequency represented by  $1/\Delta t$  in the message line of the display. If you want to turn off the cursors, press the **Clear Cursors** softkey.

### When a Single-Channel Measurement Will Not Work

If the input waveform has an irregular pattern that repeats, you can accurately measure the frequency or period by positioning the cursors at the beginning of the first and second cycles. Then, read the frequency or period in the measurement field.

Table 5

Readout Settings

Setting	Indicator	Meaning	Application
Time	t1	Time at cursor t1 with respect to trigger.	Measure delta t of waveform events with respect to trigger event, or measure period or frequency for irregular waveforms.
	t2	Time at cursor t2 with respect to trigger.	
	delta t	Time between t1 and t2.	
	1/delta t	Frequency corresponding to the measured delta t.	
Binary	Bin (t1)	Binary value of all channels in the order 15-0 (where 15 is MSB) at cursor t1, plus edge information where applicable.	Gather binary state information for a group of signals at a particular waveform event.
	Bin (t2)	Binary value of all channels in the order 15-0 (where 15 is MSB) at cursor t2, plus edge information where applicable.	
Hex	hex (t1)	Hexadecimal value of channels that are on in the order they are displayed, at cursor t1, plus edge information where applicable. The MSB is the channel at the top of the display. If any edges are found, the character is displayed as an up arrow, down arrow, or double arrow for rising, falling, or both edges respectively.	Gather hexadecimal state information for a group of signals at a particular waveform event.
	hex (t2)	Hexadecimal value of channels that are on in the order they are displayed, at cursor t2, plus edge information where applicable. The MSB is the channel at the top of the display. If any edges are found, the character is displayed as an up arrow, down arrow, or double arrow for rising, falling, or both edges respectively.	



## To measure waveform parameters on a single channel

- 1 Press `Single Channel` .
- 2 Select the channel on which you want to make a measurement by using the Entry knob or Select knob, or by pressing the **source** softkey.  
If you want to measure a parameter for a channel that is off, first turn the channel on.
- 3 Select a measurement.
  - To measure frequency, press the **Freq** softkey.
  - To measure period, press the **Period** softkey.
  - To measure duty cycle, press the **Duty Cy** softkey.
  - To measure positive width, press the **Next Menu** softkey, then press the **+Width** softkey.

The *positive width* of a waveform is the time for which that waveform is high (logic 1).

- To measure negative width, press the **Next Menu** softkey, then press the **-Width** softkey.

The *negative width* of a waveform is the time for which that waveform is low (logic 0).

The selected measurement appears in the measurement field of the display. The measurement field shows a maximum of three measurements. If you select additional measurements beyond those three, the left-hand measurement is deleted and others are moved left to make room for the new measurement. If you select a measurement that is already displayed, it is moved to the rightmost position in the measurement field.

You must select the desired channel before pressing the softkey to start the measurement.

You may repeat the above steps as desired to measure parameters of different input channels. The three most recent single- or dual-channel measurements (of any kind) will be shown on the message line of the display.

The measurement algorithms are as follows:

- To calculate input frequency, the analyzer selects the first and third transitions at the left side of the visible display, measures the delta time between these two transitions, then calculates the frequency as  $1/\Delta$  time.
- To calculate input period, the analyzer selects the first and third transitions at the left side of the visible display and measures the  $\Delta$  time between these two transitions.
- To calculate the duty cycle, the analyzer measures the period and positive width. It then calculates duty cycle by dividing the period into the pulse width, multiplying the result by 100%.
- To calculate the positive width, the analyzer measures the time between the first set of transitions that begin and end a logic high from the left side of the visible display.
- To calculate the negative width, the analyzer measures the time between the first set of transitions that begin and end a logic low from the left side of the visible display.

To show the parameters of the most recent measurement, which is the rightmost one in the measurement results line, press the **Show Meas** softkey until **On** is highlighted. The analyzer will activate the cursors to show which transitions were selected for that measurement. To clear the current measurement results, press the **Clear Meas** softkey. With the HP 54620C, the tracked measurement results will be displayed in the cursor color.

#### Ensuring Transitions for Input Waveforms having Irregular Patterns

For input waveforms having an irregular pattern (such as PCM signals), you must ensure that the transitions for which you want to measure a parameter are at the left side of the display. For some waveforms of this type, using the cursors to make the measurement may be a better solution. See "To use the cursors."

## To measure channel-to-channel delay

Channel-to-channel delay is the time between a particular event on one channel and another event on another channel. For example, you might use this measurement to check skew between two signals in your circuit; in this case, you would measure the time between the same event occurring on each channel.

- 1 Press **Dual Channel**.
- 2 Press the **Ch Delay** softkey.
- 3 Press the leftmost **Channel** softkey to highlight the start channel.  
The *start channel* is the reference point for the delay measurement. That is, the *delay time* is the time between the first transition on the start channel and the first transition on the end channel. (Each transition must meet the rising- or falling-edge specification as defined by the setup.)
- 4 Select the start channel by using the Entry knob or Select knob, or by repeatedly pressing the leftmost **Channel** softkey.
- 5 Select whether the measurement should be referenced to the rising or falling edge of the start signal by pressing the leftmost **Edge** softkey to highlight the rising or falling edge symbol.
- 6 Press the rightmost **Channel** softkey to highlight the end channel.  
The *end channel* is the channel for which you want to measure delay time.
- 7 Select the end channel by using the Entry knob or Select knob, or by repeatedly pressing the rightmost **Channel** softkey.
- 8 Select whether the measurement should be referenced to the rising or falling edge of the end signal by pressing the leftmost **Edge** softkey to highlight the positive or negative edge symbol.  
You must select the desired channels and clock edge before pressing the **Measure Chan Delay** softkey to start the measurement in the next step.

## 9 Press Measure Chan Delay.

The channel-to-channel delay time appears on the message line of the display. You may repeat the above steps as desired to measure the delay time between different sets of input channels. The three most recent single- or dual-channel measurements (of any kind) will be shown on the message line of the display.

To calculate the delay time, the analyzer measures the time between the first transition of the selected type (rising or falling) on the start channel and the first transition of the selected type (rising or falling) on the end channel. When looking for the transition on the start channel, the analyzer begins at the left side of the visible display. So, if the correct transition is found first on the start channel, the result will be positive; otherwise, it will be negative. In delayed mode, the analyzer uses the part of the waveform shown by the delayed sweep.

## To measure setup time

*Setup time* is usually defined as the time for which a data input to a clocked device must remain stable before the active edge of the clock occurs.

Violating the setup time specification of a device can lead to unstable circuit operation. You can use the Setup Time measurement in the HP 54620A/C to verify that your circuit design meets the device specifications.

**1** Press Dual Channel.

**2** Press the **Setup** softkey.

**3** Press the softkey under the heading **Data** to highlight the data channel.

The *data channel* is the channel for which you want to measure setup time.

**4** Select the data channel by using the Entry knob or Select knob, or by repeatedly pressing the **Data** softkey.

**5** Press the **Clock** softkey to highlight the clock channel.

The *clock channel* is the reference point for the setup time measurement. That is, the setup time is the time between a transition on the data channel and a subsequent transition on the clock channel.

**6** Select the clock channel by using the Entry knob or Select knob, or by repeatedly pressing the **Clock** softkey.

**7** Select whether the measurement should be referenced to the rising or falling edge of the clock signal by pressing the **Edge** softkey to highlight the positive or negative edge symbol.

You must select the desired channels and clock edge before pressing the **Meas Setup** softkey to start the measurement in the next step.

**8** Press **Meas Setup**.

The setup time appears on the message line of the display.

You may repeat the above steps as desired to measure the setup time between different sets of input channels. The three most recent single- or dual-channel measurements (of any kind) will be shown on the message line of the display.

To calculate the setup time, the analyzer measures the time between the first transition of the selected type (rising or falling) on the clock channel and the nearest previous transition on the data channel. A glitch on the data channel will be considered a transition for measurement purposes.

**Example**

The following display shows a setup time measurement, where the data channel is channel 1, and the clock channel is channel 0.

**Figure 27**

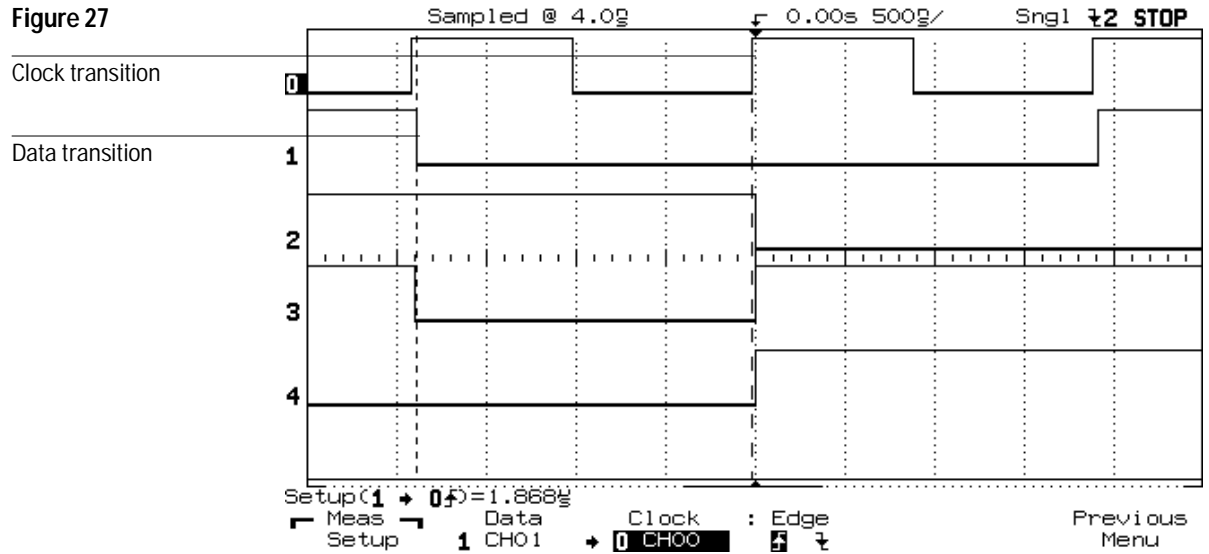

**Setup Time Measurement**

## To measure hold time

*Hold time* is usually defined as the time for which a data input to a clocked device must remain stable after the active edge of the clock occurs. Violating the hold-time specification of a device can lead to unstable circuit operation. You can use the Hold Time measurement in the HP 54620A/C to verify that your circuit design meets the device specifications.

**1** Press Dual Channel .

**2** Press the **Hold** softkey.

**3** Press the **Clock** softkey to highlight the clock channel.

The *clock channel* is the reference point for the hold time measurement. That is, the *hold time* is the time between a transition on the clock channel and a subsequent transition on the data channel.

**4** Select the clock channel by using the Entry knob or Select knob, or by repeatedly pressing the **Clock** softkey.

**5** Select whether the measurement should be referenced to the rising or falling edge of the clock signal by pressing the **Edge** softkey to highlight the positive or negative edge symbol.

**6** Press the **Data** softkey to highlight the data channel.

The *data channel* is the channel for which you want to measure hold time.

**7** Select the data channel by using the Entry knob or Select knob, or by repeatedly pressing the **Data** softkey.

You must select the desired channels and clock edge before pressing the **Meas Hold** softkey to start the measurement in the next step.

**8** Press **Meas Hold**.

The hold time appears on the message line of the display.

You may repeat the above steps as desired to measure the hold time between different sets of input channels. The three most recent single- or dual-channel measurements (of any kind) will be shown on the message line of the display.

To calculate the hold time, the analyzer measures the time between the first transition of the correct type (positive- or negative-going) on the data channel and the previous clock transition. A glitch on the data channel will be considered a transition for measurement purposes.

**Example**

The following display shows a hold time measurement, where the clock channel is channel 0, and the data channel is channel 1:

**Figure 28**

Clock transition

Data transition

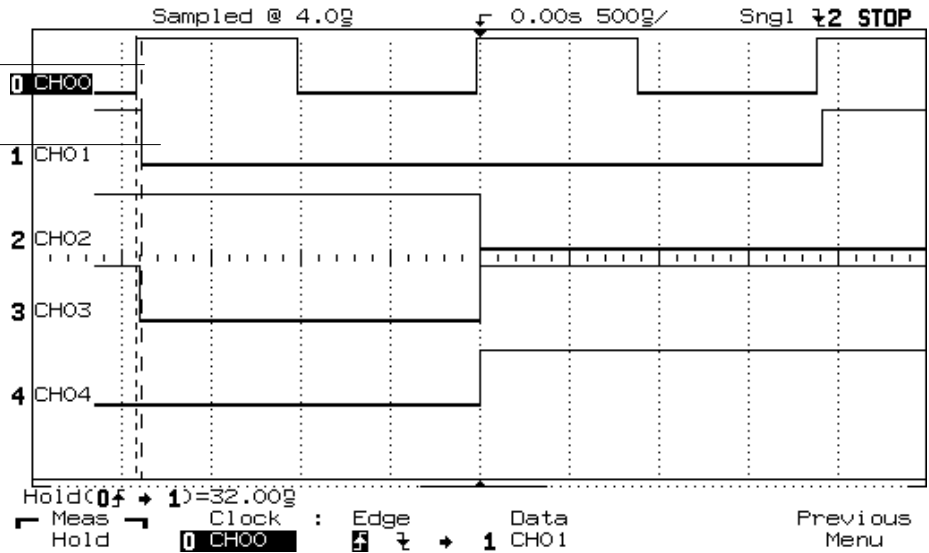

**Hold Time Measurement**



---

## Using the Analyzer with Other Instruments

The HP 54620A/C provides two features that help extend the triggering capabilities of the analyzer and allow you to use it with other instruments:

- External trigger input
- Trigger output

---

### Extending trigger capabilities

#### **External Trigger Input**

The external trigger input allows you to trigger the HP 54620A/C from another instrument or another signal in the circuit under test.

- In the first case, you may be using the capability of the other instrument to help qualify the trigger condition before triggering the analyzer.
- In the second case, you may simply need a “17th channel” or need to trigger from an analog signal where the inputs are not directly appropriate for analyzer input, but which can be input safely using a 10:1 divider probe.

The external trigger signal is available in edge, pattern, and advanced trigger to use as either an edge or pattern qualifier for the trigger condition.

Figure 29 shows the first case, where you might trigger the analyzer by using the trigger output of an emulator. Figure 30 shows the second case, using an oscilloscope probe to route the signal to the external trigger input.

Figure 29

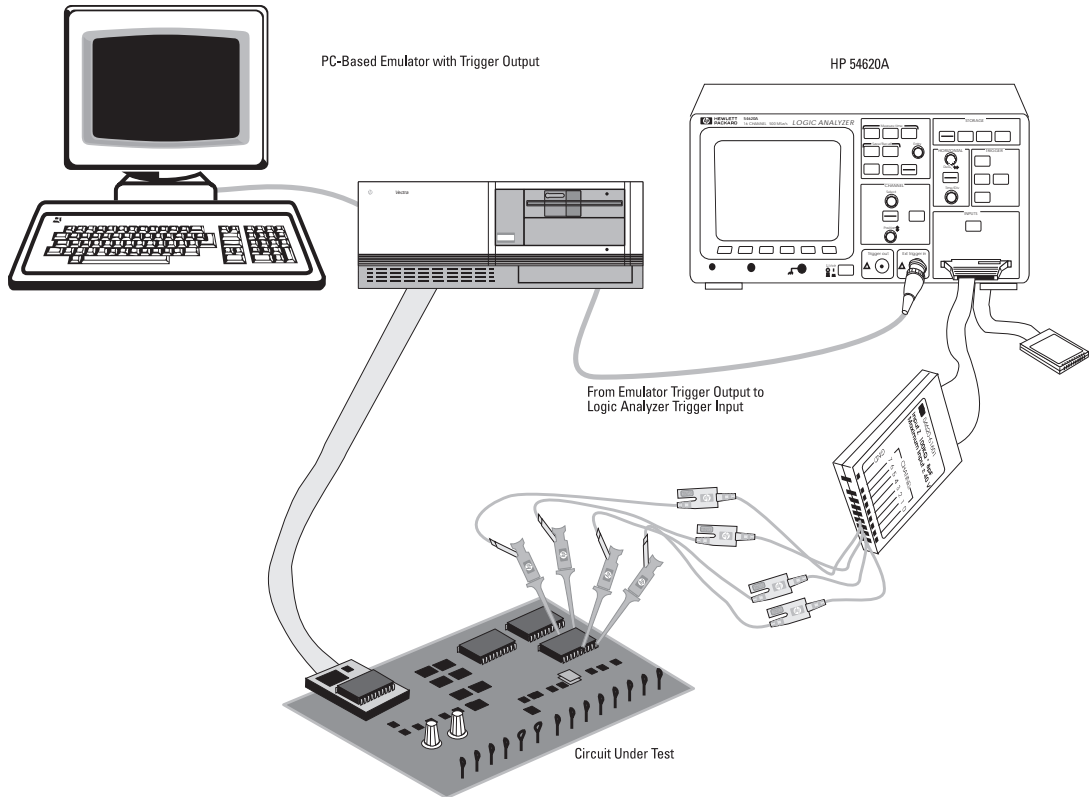

Connections for External Trigger from an Emulator

Figure 30

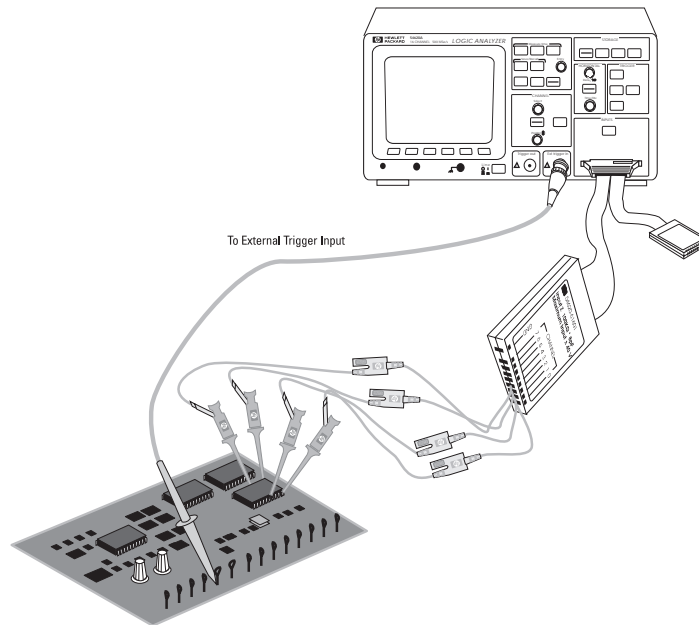

#### Connections for External Trigger using an Oscilloscope Probe

The external trigger input can have a logic threshold setting independent of channels 0-15. You may use a divider probe if needed to adjust the input signal to a range compatible with the analyzer. However, you need to ensure that you do not reduce the signal swing to less than the 500 mV required swing about the threshold voltage. For example, if the input signal is 3 V, and you use a 10:1 divider probe, the input swing will be 300 mV, which is insufficient.

The waveform present at the external trigger input cannot be displayed.

### Trigger Output

The trigger output is pulsed when the analyzer's trigger condition is satisfied and the analyzer begins acquiring data. Thus, it can be used to trigger an external measurement system or other device. For example, you might want to use the trigger output to trigger an oscilloscope, or even to trigger another HP 54620A/C for complex problems requiring more channels. The trigger output signal cannot be viewed on the waveform display.

A rising edge at the trigger output indicates that the trigger condition was satisfied. The trigger output occurs shortly after the trigger data occurs, typically 85 ns. Because of the overhead of acquisition and display, the trigger is not driven every time the trigger condition occurs in the target system. It is driven as often as is practical. If the logic analyzer is in Run mode (continuous acquisition), you can speed repetition of the trigger output by pressing the Run/Stop key to stop acquisition.

You can also use the trigger output for single-shot events. When you press the Single key, the analyzer will drive the trigger output high when the trigger condition is found. The trigger output will not go low again until another acquisition begins; the signal is driven low while the analyzer searches for the trigger condition. If you stop the analyzer before the trigger is found, there will not be a trigger output.

Figure 31 shows the connections required for triggering an oscilloscope from the HP 54620A/C.

**Figure 31**

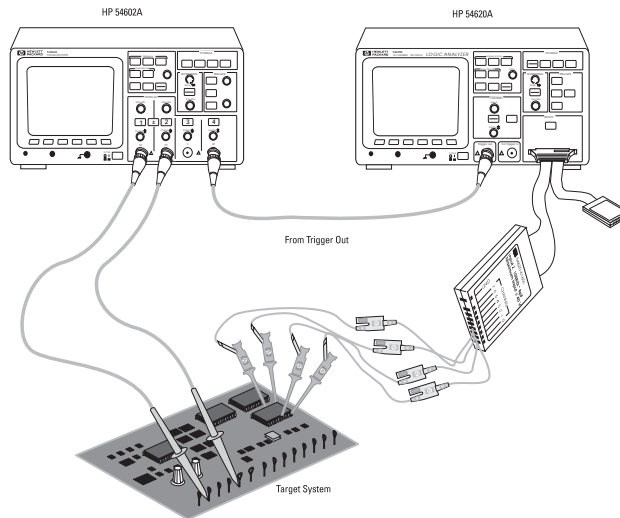

**Connections for Triggering an Oscilloscope**

## To use the external trigger input



### 1 Connect a signal to the BNC labeled “Ext trigger in.”

The “Ext trigger in” BNC is the rightmost one on the HP 54620A/C front panel. It has an input impedance of 1 M $\Omega$  and can accept a maximum signal of  $\pm 40$  V. You can connect the trigger output of other instruments to the external trigger input, or use an oscilloscope probe, such as the HP 10071A.

### 2 Set up the proper threshold voltage for the input using the Logic levels menu.

See “To change the logic threshold for input signals.” The external trigger threshold is represented as **E Trg In** under the **Set** softkey.

### 3 Set up an edge, pattern, or advanced trigger specification using the external trigger input as part of the specification.

The external trigger input is labeled as “Ext” in the pattern, and is selectable with either the Select knob or the Entry knob during pattern or edge definition. See “To define an edge trigger,” “To define a pattern trigger,” or “To define an advanced trigger.”

The external trigger input is useful when it is not practical to completely qualify the desired trigger pattern using only the logic inputs. For example, you may want to trigger the analyzer only after another instrument has found a trigger. Or, you may need to use all logic channels for input data, and need just one additional channel for an edge trigger. Or, you may want to use a scope probe to examine a system signal with larger signal swings than allowed by the logic inputs.

**Example**

Consider a situation where you have a squarewave that swings from 0 V to +60 V; thus, it is too large for the logic inputs *or* the external trigger input. However, by using a 10:1 divider probe, such as are in the HP 54620A/C, you can safely apply the squarewave to the external trigger input. You can then set the threshold for the external trigger to +3.0 V (60 divided by 2 divided by 10). Then, set an edge trigger for the rising or falling edge as desired.

**Signal Margin on External Trigger**

The above example uses a 10:1 divider probe because of the large swing of the analog signal. But, consider the situation where the analog signal swing is 0 to 4 V. The 10:1 divider will reduce this to a 400 mV swing. However, the minimum input swing required by the analyzer is 500 mV about the threshold. Thus, the analyzer input will not reliably recognize the signal transitions. The solution is to use a 1:1 probe. See chapter 7, "Performance Characteristics," for more information on the input characteristics of the analyzer.

Figure 32

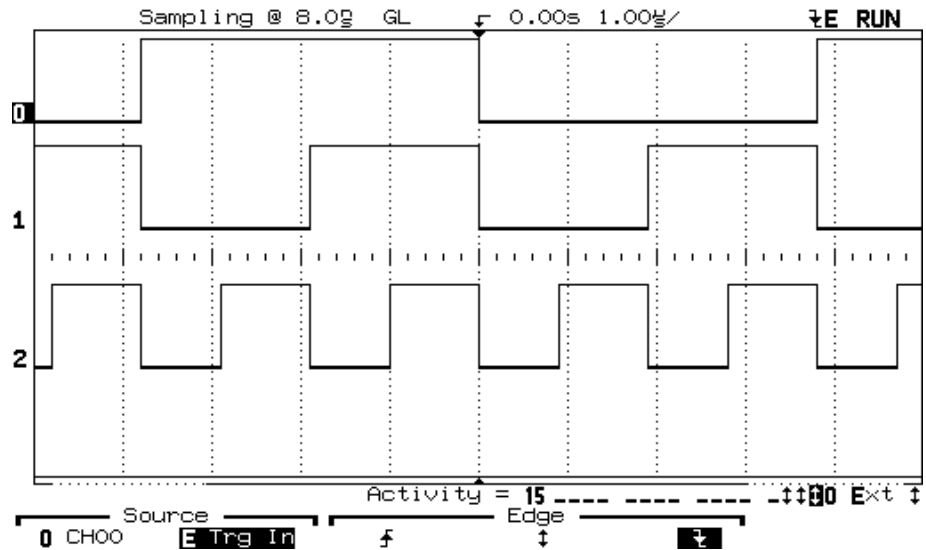

Using the External Trigger Input as an Edge Trigger

---

## To use the trigger output



- 1 Connect the trigger output to the instrument or device you want to trigger.

The trigger output is labeled “Trigger out” on the front panel of the HP 54620A/C. Usually, you will connect this to the external trigger input of another instrument, using a BNC cable. Output signal swings are 0 to 2.7 V at an output impedance of 50  $\Omega$ .

- 2 Set the desired trigger condition for the HP 54620A/C.

See “To define an edge trigger,” “To define a pattern trigger,” or “To define an advanced trigger.”

- 3 Set the desired trigger condition for the external trigger input of the target instrument.

This usually consists of setting trigger level and edge, but may include other parameters. See the manual for the instrument in question.

- 4 Start an acquisition on the HP 54620A/C by pressing **Run** , **Single** , or **Autostore** .

As the HP 54620A/C finds its trigger condition, it pulses the trigger output signal.

### Stop Acquisition to Increase Trigger Output Rate

While in Run mode, the HP 54620A/C can only generate trigger outputs as fast as it can acquire the data and update the waveform display. This is normally fast enough to trigger digital oscilloscopes. However, it is not fast enough to ensure a usable display for analog oscilloscopes. To obtain a faster trigger for these instruments, stop acquisition on the HP 54620A/C by pressing the Stop key. The HP 54620A/C will continue to recognize its trigger condition and will drive the trigger output, but does not have the overhead of data capture display updates. Thus, the trigger output is generated at a much higher rate. The trigger status is still valid.

---

## Saving and Recalling the Configuration

The HP 54620A/C allows you to save a visual record of measurement results (*trace memory*) and instrument configurations (*setup memory*).

---

### Using memories to save and recall configurations

#### **Trace memory**

Two trace memories, also called pixel memories, are available in the HP 54620A/C. These allow you to save the visible portion of the acquisition—the displayed waveform—for later recall and comparison with other measurements. To ensure repeatability of the measurement, should you decide to repeat it after recalling a result from trace memory, the setup is saved with the waveform, and can be independently recalled. The two setup memories associated with the trace memories are independent of the 16 regular setup memories.

The normal application for trace memory is quick comparison of measurement results. For example, you might make a measurement on a known good system, save the result in trace memory, then make the same measurement on a known bad system and recall trace memory to see the differences.

#### **Add an Interface Module to Make Memory Non-Volatile**

Trace memory is normally volatile. Adding an interface module, such as the HP 54650A HP-IB Interface, or HP 54652A/B or HP 54651A RS-232 Interface, makes the trace memory non-volatile.

Figure 33 shows the trace memory softkey menu.



Figure 33

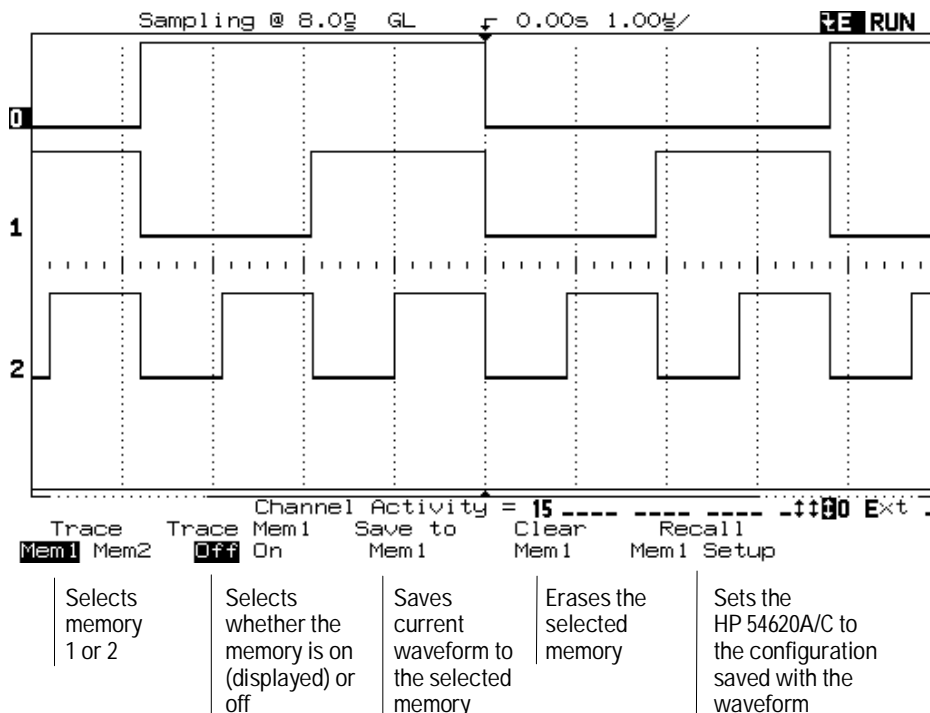

**Trace Memory Save/Recall**

**Setup memory**

The HP 54620A/C has 16 separate setup memories that allow you to save the current configuration of the instrument, including time base, threshold, channel settings, measurement definitions, and labels (but not as 16 independent label lists). These memories are non-volatile. They are best used for saving instrument configurations that you need later to verify the results of a change, or need regularly for test and troubleshooting.

For example, suppose that you use the HP 54620A/C in field testing of a system where ten separate tests are used. You can predefine the test configurations and save them in setup memories 1-10. You might also record the expected results as part of field test documentation. Then, a field service engineer can take the instrument, connect it to a customer system, recall each setup in turn, and compare the results to the expected results. This will save test time and will increase accuracy, because preconfiguration minimizes the chance for error.

The current acquisition results are not saved in the setup memory. To save acquisition results for later review and comparison, use the trace memory.  
Figure 34 shows the setup memory softkey menu.

Figure 34

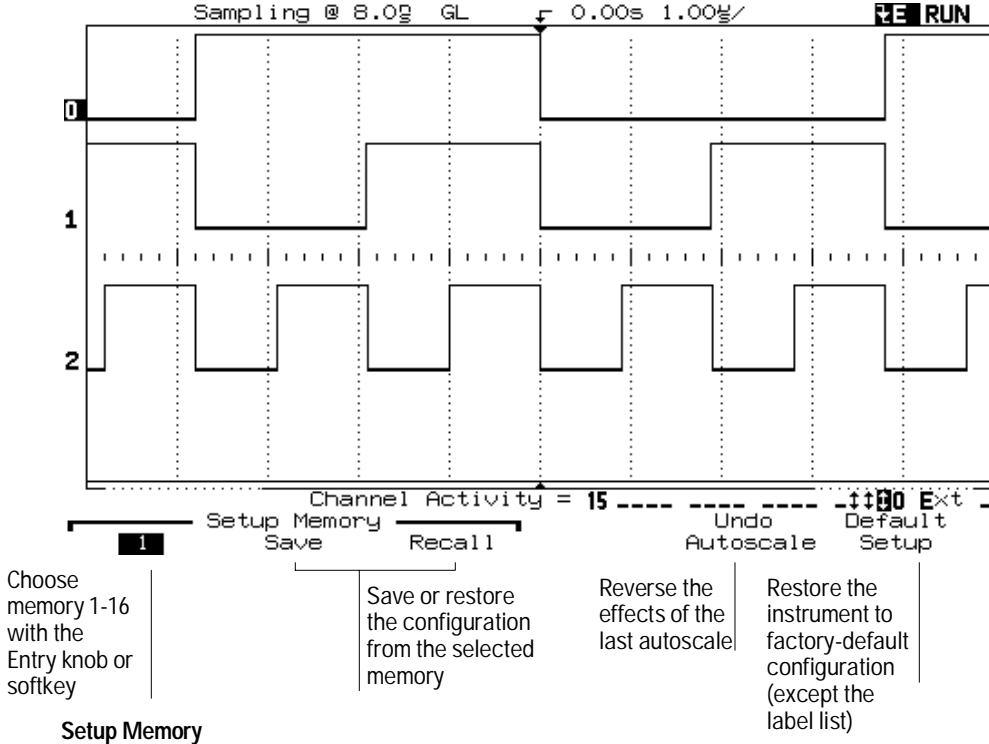

## To save a trace waveform

- 1 Press  .
- 2 Press the **Trace** softkey to choose either **Mem1** or **Mem2**.  
**Mem1** and **Mem2** correspond to the two pixel memories where you can save the waveform.
- 3 Press **Save to Mem** to save the currently displayed waveform.  
**Save to Mem** will appear as either **Save to Mem1** or **Save to Mem2**, depending on the pixel memory you selected in step 2.  
The analyzer saves the current trace waveform display and the instrument setup in the selected memory.

---

## To recall a trace waveform

- 1 Press Trace .
- 2 Press the **Trace** softkey to choose either **Mem1** or **Mem2**.  
**Mem1** and **Mem2** correspond to the two pixel memories in which a waveform might have been saved.
- 3 Recall the contents of pixel memory:
  - To recall the waveform and the instrument setup that was in effect when the waveform was stored, press **Recall Setup**.  
The Recall Setup softkey will be either **Recall Mem1 Setup** or **Recall Mem2 Setup**, depending on the memory chosen in step 2.
  - To recall only the stored waveform, press the **Trace Mem** softkey until **On** is highlighted.  
Trace Mem will be either **Trace Mem1** or **Trace Mem2**, depending on which memory was chosen in step 2. You can turn off the memory by pressing the Trace Mem softkey until **Off** is highlighted.

## To clear a previously saved trace

- 1 Press  .
- 2 Press the **Trace** softkey to choose either **Mem1** or **Mem2**.  
**Mem1** and **Mem2** correspond to the two pixel memories in which a waveform might have been saved.
- 3 Press the **Clear Mem** softkey.  
**Clear Mem** will be either **Clear Mem1** or **Clear Mem2**, depending on which memory you selected in Step 2.  
The waveform is cleared from the selected trace memory. However, the setup information is not cleared from that memory. So, if you press **Recall Setup** after pressing **Clear Mem**, the setup in effect at the time that memory was saved is restored.

---

## To save the instrument setup

- 1 Press **Setup** .
- 2 Select the setup memory using the Entry knob.  
or  
Toggle the leftmost key under the **Setup Memory** banner.  
You can store and recall sixteen different setups, numbered 1 through 16.
- 3 Press the **save** softkey.  
The current measurement configuration is stored in the specified memory.  
Because the setup memories are non-volatile, they are convenient for storing test configurations that you might use repeatedly in different field test and repair situations. The analyzer also stores the label settings in the setup.

## To recall the instrument setup

- 1 Press  .
- 2 Select the setup memory using the Entry knob.  
or  
Toggle the leftmost key under the **Setup Memory** banner.  
You can store and recall sixteen different setups.
- 3 Press the **Recall** softkey.  
The measurement configuration of the instrument is set based on the information stored in the specified memory.

## To reset the instrument setup

- To reset the instrument to the factory-preset defaults, press the **Default Setup** softkey.
- To reset the instrument to the configuration that was present before autoscale, press the **Undo Autoscale** softkey.

**Table 6**

**HP 54620A/C Factory-Preset Default Configuration Settings**

<b>Configuration Item</b>	<b>Setting</b>
Single-Channel Measurements	Channel 0 is source; show measurements is on; no measurement is selected.
Dual-Channel Measurements	Channel 0, rising edge is first source; Channel 1, rising edge is second source; show measurements is on; no measurement is selected.
Cursors	Cursors off; time readout is selected; all cursors are set to time zero.
Trace memories	Both trace memory 1 and 2 are off; trace 1 memory is selected.
Graticule	Set to full.
Autostore	Off.
Time base	Time reference center; main, not delayed sweep; vernier off; main and delay value 0; 100 $\mu$ s/div main time base; 500 ns/div delayed time base; sample period 800 ns.
Display	Default color palette selected for HP 54620C.
Channels	All channels on; channel 0 selected; order 0-15.
Labels	Labels on; labels CH00, CH01, ...,
Threshold	TTL (1.5 V) for all channels and external trigger input; channel 0-7 threshold is selected when menu is entered.
Trigger Mode and Condition	Normal Trigger Mode with edge trigger.
Edge Trigger	Rising edge on channel 0.
Pattern Trigger	All channels don't care.
Advanced Trigger	Default condition is Duration > on Pattern 1. Pattern 1 and 2 mask and value is 0, minimum duration 2 samples. Edge 1 and 2 rising on channel 0, occurrence count 1.
Auto Glitch Detect	Enabled.
Waveform Colors	Channels 0-3 - yellow, 4-7 - magenta, 8-11 - cyan, and 12-15 - red. (HP 54620C only)





---

## Solving Problems

---

## Solving Problems

This chapter describes possible solutions if you encounter problems while making measurements with the instrument. If you need to verify instrument functionality and performance, refer to chapter 5, “Testing, Adjusting, and Troubleshooting the Analyzer.”

---

## If there is no trace display

- Check that the power cord is connected to the HP 54620A/C and to a live power source.

- Check that the front-panel power switch is set to 1 (on).

- Check that the display is on and the brightness is adjusted correctly.

If there is no display, see the troubleshooting procedures in chapter 5, “Testing, Adjusting, and Troubleshooting the Analyzer.”

- Check that the analyzer probe cable is securely connected to the input connector. The key on the probe cable should be facing down.

- Check that the analyzer probe lead wires are securely inserted into the connector assembly and that the grabbers make good contact with the probe lead wires.

- Check that the grabbers are securely connected to the nodes of the circuit under test.

- Check that the circuit under test is powered on.

- Press Autoscale.

If the activity indicators do not show any activity on any input channels, the circuit under test may be powered off, inactive, or malfunctioning.

- Reset the logic analyzer.

- To reset the analyzer without initializing the label list, press and hold any front-panel key (except the Label key) and switch the analyzer power on. Release the key when the measurement display appears.

- To reset the entire analyzer, press and hold the two rightmost softkeys and switch the analyzer power on. Release the two keys when the measurement display appears.

or

Press and hold the Label key and switch the analyzer power on. Release the key when the measurement display appears.

- Obtain HP service, if necessary.

## If the trace display is unusual or unexpected

- Check that the Time/Div setting is correct for the expected frequency range of the input signals.

The sampling speed of the analyzer depends on the Time/Div setting. Thus, when the Time/Div setting is slower than 1  $\mu\text{s}/\text{div}$ , the analyzer may be sampling too slowly to capture all the transitions on the waveform. If Auto Glitch Detect mode is disabled, the display might be an alias.

- Check that all analyzer probes are connected to the correct signals in the circuit under test.
- Check to see that the ground lead from the cable is securely connected to ground in the circuit under test. For high-speed measurements, each probe's individual ground should also be connected to a ground point closest to the signal point in the circuit under test.

See chapter 4 for more information on probing considerations.

- Check that the threshold setting for the analyzer inputs is correct for the logic family in use in the circuit under test.

If the activity display does not show the channel toggling, either there is no signal or the threshold setting is incorrect. (Very slow signals will not show a double arrow for activity; instead, the dash will switch from low to high or vice-versa whenever the signal toggles.)

- Check that the trigger setup is correct.

A correct trigger setup is probably the most important factor in helping you capture the desired data. See chapter 2, "Making Analyzer Measurements," for information on triggering, particularly pattern and advanced triggers. See chapter 4, "Ensuring Accurate Measurements," for information on logic analyzer triggering concepts.

- Check that Autostore is turned off, then press Erase.
- Press Autoscale.
- Check the activity indicators to be sure there are active signals on the analyzer input channels.

---

## If you can't see a channel

- Check that the analyzer probe cable is securely connected to the input connector. The key on the probe cable should be facing down.
- Check that the analyzer probe lead wires are securely inserted into the connector assembly and that the grabbers make good contact with the probe lead wires.
- Check that the grabbers are securely connected to the nodes in the circuit under test.

- Check that the circuit under test is powered on.

You may have pressed Autoscale with no input signal available.

Performing the checks described above ensures that the signals from the circuit under test are seen by the analyzer.

- Check that the threshold setting for the analyzer inputs is correct for the logic family in use in the circuit under test.

If there is no activity on the channel activity indicators, the ground lead may not be connected, the threshold setting may be incorrect, or there may be no activity on that signal in the circuit under test.

- Check that the desired channels are on.
  - 1** Press On/Off.
  - 2** Make sure the selected desired channels are on by using the Entry knob or Select knob to scroll through the channels. Then press On for each channel that should be on, but is off.
- Use Autoscale to obtain an automatic setup for all channels.



---

## Ensuring Accurate Measurements



---

# Ensuring Accurate Measurements

This chapter gives an overview of some analyzer concepts that will help you make better measurements. It discusses the relationship between the time base setting and other time-dependent analyzer functions, explains how to achieve the most accurate signal fidelity through good probing practices, and describes how glitch detection works.

## Time base and Acquisition

The analyzer acquires data by sampling the voltage on each input channel and comparing it to the threshold voltage to determine whether the input was a logic high or logic low. The interval at which the input is sampled is called the *sample period*.

Because there is a finite amount of acquisition memory in the HP 54620A/C, the instrument is optimized to deliver the smallest sample period possible, while still acquiring enough data to provide at least a full screen of waveform at any Time/Div (or *time base*) setting. To achieve this goal, the analyzer must vary the sample period as a function of the time base setting. Other analyzer functions that depend on the sample period, such as duration trigger, are therefore affected when the time base setting is changed.

Consider what would happen if the sample period were not varied with respect to the time base setting. If the sample period remained constant at 2 ns, at 1 s/div, the waveform would occupy a little over 16  $\mu$ s (for 8 Ksamples). Thus, it would not be visible on the screen, because 16  $\mu$ s is only a small fraction of a single division at this sweep speed. This would defeat the goal of switching to a larger Time/Div value, which is to see data over a larger span of time.

However, because acquisition mode, trigger functions, delayed sweep, and measurement functions depend on the sample period, you must be aware of the relationships to ensure that you achieve the desired measurement results.

Figure 35

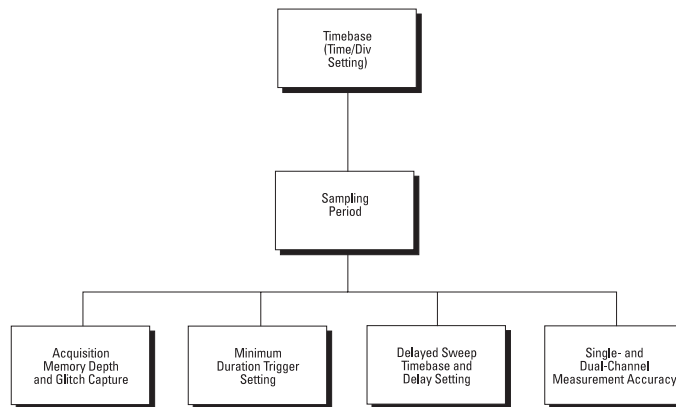

Relationship Between Time base and Analyzer Functions

The following table shows how the sampling intervals vary with sweep speed when Auto Glitch Detect is enabled and disabled. The vernier function is off.

**Table 7**

<b>Sweep Speed and Sampling Interval</b>								
	<b>Auto Glitch Detect</b>			<b>Auto Glitch Detect</b>			<b>Auto Glitch Detect</b>	
	<b>Enabled</b>	<b>Disabled</b>		<b>Enabled</b>	<b>Disabled</b>		<b>Enabled</b>	<b>Disabled</b>
<b>Time/ Div</b>	<b>Sample Period</b>	<b>Sample Period</b>	<b>Time/ Div</b>	<b>Sample Period</b>	<b>Sample Period</b>	<b>Time/ Div</b>	<b>Sample Period</b>	<b>Sample Period</b>
5 s	n/a	8 ms	5 ms	40 $\mu$ s	8 $\mu$ s	5 $\mu$ s	40 ns	8 ns
2 s	n/a	4 ms	2 ms	16 $\mu$ s	4 $\mu$ s	2 $\mu$ s	16 ns	4 ns
1 s	8 ms	1.6 ms	1 ms	8 $\mu$ s	1.6 $\mu$ s	1 $\mu$ s	8 ns	2 ns
500 ms	4 ms	800 $\mu$ s	500 $\mu$ s	4 $\mu$ s	800 ns	500 ns	4 ns	2 ns
200 ms	1.6 ms	400 $\mu$ s	200 $\mu$ s	1.6 $\mu$ s	400 ns	200 ns	2 ns	2 ns
100 ms	800 $\mu$ s	160 $\mu$ s	100 $\mu$ s	800 ns	160 ns	100 ns	2 ns	2 ns
50 ms	400 $\mu$ s	80 $\mu$ s	50 $\mu$ s	400 ns	80 ns	50 ns	2 ns	2 ns
20 ms	160 $\mu$ s	40 $\mu$ s	20 $\mu$ s	160 ns	40 ns	20 ns	2 ns	2 ns
10 ms	80 $\mu$ s	16 $\mu$ s	10 $\mu$ s	80 ns	16 ns	10 ns	2 ns	2 ns
						5 ns	2 ns	2 ns

**Acquisition Memory**

At sweep speeds from 1 s/div to 1  $\mu$ s/div, the analyzer has acquisition memory that is 16 bits wide and 2048 samples deep, and automatic glitch detection is enabled. Part of the analyzer memory is consumed by automatic glitch detection circuitry. When the sweep speed becomes faster than 1  $\mu$ s/div, the glitch detection circuitry is disabled, and acquisition memory is 16 bits wide and 8192 samples deep. See “Glitch Detection” in this chapter for more information.

**Storage of Samples** The following figure shows a conceptual representation of acquisition memory. You can think of the trigger event as dividing acquisition memory into a pre-trigger and post-trigger buffer. The position of the trigger event in acquisition memory is defined by the trigger reference point and the delay setting.

Figure 36

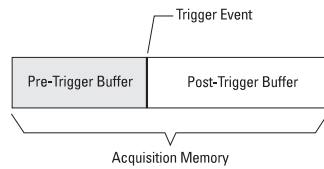

### Acquisition Memory

**Normal Mode** In Normal trigger mode, the analyzer behaves the same when the acquisition was initiated by pressing either Run or Single. The analyzer begins filling the pre-trigger buffer with data. As soon as that buffer is full, the analyzer will begin searching for the trigger event, and will flash the trigger condition indicator. While searching for the trigger, the analyzer overflows the pre-trigger buffer, with the first data put into the buffer being the first pushed out (FIFO).

When the trigger event is found, the analyzer will fill the post-trigger buffer and display the acquisition memory. If the acquisition was initiated by Run/Stop, the process repeats.

**Auto Mode** The analyzer fills the pre-trigger buffer, then searches for the trigger event for a predetermined interval. This interval is a function of the Time/Div setting, but is never less than 40 ms. If no trigger is found, the analyzer forces a trigger and displays the data as though a trigger occurred. The subsequent behavior depends on whether the acquisition was initiated by pressing Single or Run:

- Single—the analyzer will fill acquisition memory, stop, and display the results.
- Run—the analyzer will fill the pre-trigger buffer after drawing a trace. When the pre-trigger buffer is full, the analyzer repeats the search for a trigger. If no trigger is found, a free-running trace is displayed, much like that of an oscilloscope on auto trigger.

In either Auto or Normal mode, the trigger may be missed completely under certain conditions. This is because the analyzer will not recognize a trigger event until the pre-trigger buffer is full. Suppose you set the Time/Div knob to a slow sweep speed, such as 500 ms/div. If the trigger condition always occurs before the analyzer has filled the pre-trigger buffer, the trigger will not be found.

Some measurements you want to make will require you to take some action in the circuit under test to cause the trigger event. Usually, these are single-shot acquisitions, where you will use the Single key. If you use Normal mode and wait for the trigger condition indicator to flash before causing the action in the circuit, the analyzer will always find the trigger condition correctly.

The Memory bar at the bottom of the waveform display shows the part of acquisition memory that is displayed, and that which is off-screen. The following figure shows how to interpret the Memory bar.

Figure 37

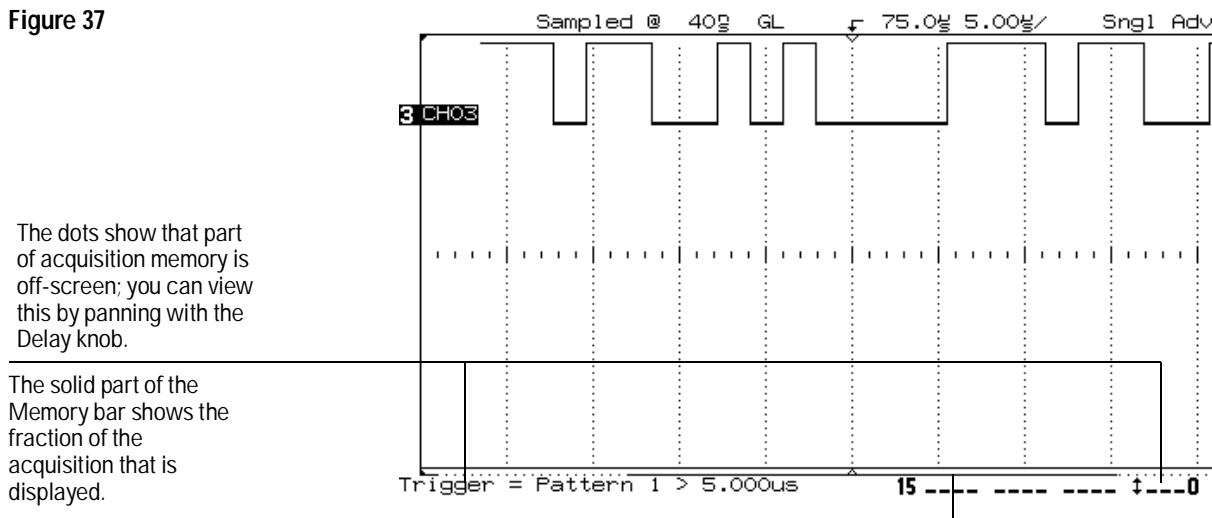

The dots show that part of acquisition memory is off-screen; you can view this by panning with the Delay knob.

The solid part of the Memory bar shows the fraction of the acquisition that is displayed.

### Memory Bar

### Trigger Functions

Both the minimum detectable pattern width and the minimum duration trigger setting depend on the current sample period. These are two different things. The minimum detectable pattern width defines the minimum time for which the input must remain stable so that the analyzer can recognize it as matching a pattern trigger specification. The minimum duration trigger setting specifies the shortest duration value that the analyzer can use.

At very fast sweep speeds (small Time/Div settings), the minimum detectable pattern width is nearly a constant value. At Time/Div settings  $2 \mu\text{s}/\text{div}$  and slower, the minimum detectable pattern width is approximately a constant value plus one sample period.

The *minimum* duration trigger setting is two sample periods or 16 ns, whichever is greater. And, the *resolution* of the duration trigger is one sample period. How might this affect your measurement? Suppose you have the sweep speed set to 2  $\mu\text{s}/\text{div}$ , and have a duration trigger set up for duration > 48 ns (three sample periods of 16 ns). If you then set the sweep speed to 10  $\mu\text{s}/\text{div}$ , the trigger will be lost, because the minimum duration trigger value at the new sweep speed is 160 ns (two sample periods of 80 ns). See chapter 7, “Performance Characteristics,” for more information.

### **Delayed Sweep and the Time Reference**

When you enable the delayed sweep view, the analyzer divides the window into two vertical portions. The upper part shows the waveform according to the main time base; the lower shows a small portion of the waveform magnified according to a second time base (the delayed sweep). In delayed sweep, the Time/Div knob adjusts the magnification of the delayed sweep portion. The delayed sweep time base must be at least twice as fast the main time base and can vary up to the maximum sweep speed of 5 ns/div. For example, at a main time base setting of 500  $\mu\text{s}/\text{div}$ , the delayed sweep time base will be adjustable from 200  $\mu\text{s}/\text{div}$  to 5 ns/div.

You must be careful not to expand the delayed sweep time base such that no useful data is displayed. If the main time base setting is 500  $\mu\text{s}/\text{div}$ , the data was obtained at a sampling interval of 4  $\mu\text{s}$ . Expanding the delayed time base so that no original samples appear in the delayed sweep will not yield any useful information. For this example, expanding the delayed sweep time base to 1  $\mu\text{s}/\text{div}$  yields two or three samples in the delayed sweep window. Expanding the delayed sweep time base beyond 1  $\mu\text{s}/\text{div}$  will not be useful.

There are two different delays: Main and Delayed. The horizontal mode determines which delay is used. When the horizontal mode is set to Main, the delay positions the main sweep relative to the trigger. This delay is a fixed number of samples in the positive and negative directions, so the time value of this delay is a function of sampling interval and therefore a function of sweep speed. Changing this delay value does not affect the sampling interval or sweep speed, however. When the horizontal mode is set to Delayed, the delay controls the position of the delayed sweep window inside the main sweep display. This delay value is independent of sampling interval and sweep speed.

## Ensuring Accurate Measurements Time base and Acquisition

The time reference position sets the general location of the trigger event within acquisition memory. A time reference position of Left sets the event to a few locations after the beginning of acquisition memory, Center sets the event to the middle of acquisition memory, and Right sets the event to a few locations before the end of acquisition memory. The delay setting sets the specific location of the trigger event with respect to the time reference position. *Thus, because the delay can be adjusted in the positive direction to greater than the depth of acquisition memory, the trigger event may or may not be stored in acquisition memory.* (The range of available negative delay is less.)

Consider a measurement where the time reference is set to Center, the sweep speed is set to  $5\ \mu\text{s}/\text{div}$  (sample interval  $40\ \text{ns}$ ), and the delay is set to  $75\ \mu\text{s}$ . A single acquisition is performed. The result looks like the following:

**Figure 38**

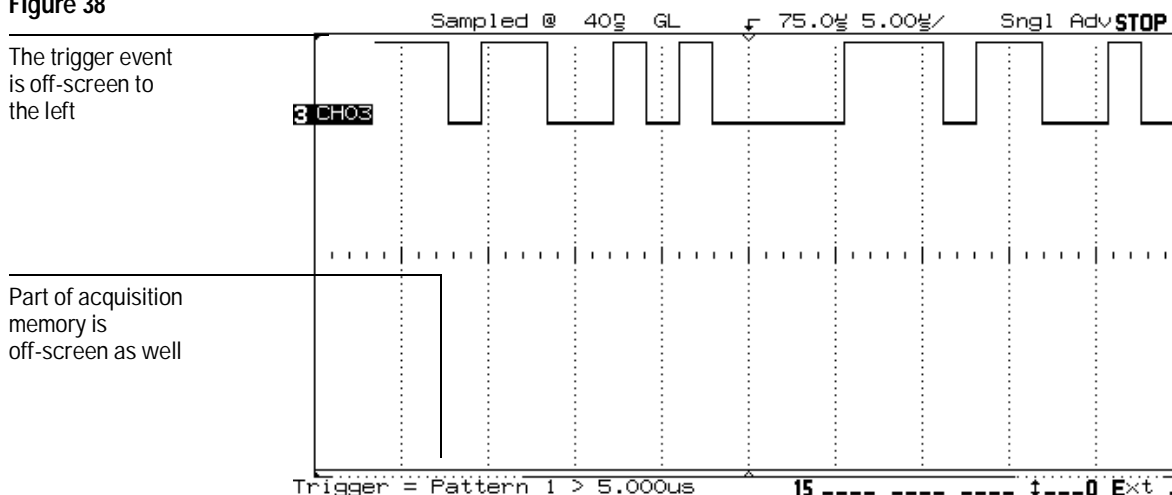

**Single Acquisition, Time Reference Center, Positive Delay of  $75\ \mu\text{s}$**

In the previous figure, the trigger point is off-screen to the left—that is why the solid triangle is at the left edge of the graticule. If you now pan the display back by setting the delay to 20  $\mu\text{s}$ , the result looks like the following:

**Figure 39**

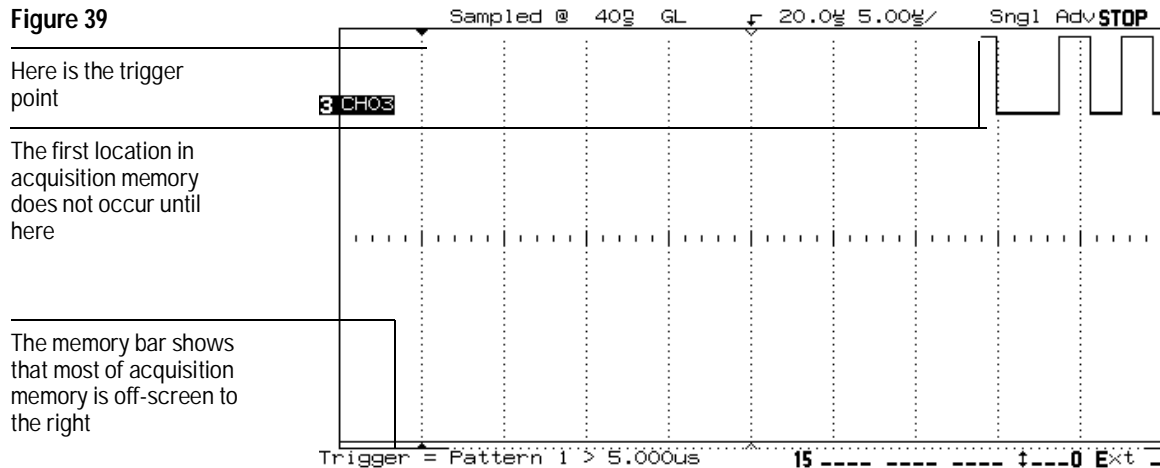

### Panning the Display to View the Start of Acquisition

Note that the trigger point (the solid triangle at the top of the graticule), while visible on-screen, occurs sometime before the first acquisition in memory. Also, you must be careful when interpreting the time reference point here—panning the display with no acquisition in process is simply panning the display—it does not change the reference point. If you start a new acquisition after stopping and panning, the delay value to which you panned will be used in determining the trigger location for the new acquisition. For example, if you acquired data with a delay value of 100  $\mu\text{s}$ , then stop and pan the display to 50  $\mu\text{s}$ , the new acquisition will position the trigger 50  $\mu\text{s}$  before the time reference point. Panning *is* a useful way to see the relationship between the trigger point and relative locations in acquisition memory.



Ensuring Accurate Measurements  
Time base and Acquisition

The range of available delay is different with negative delay values. Suppose you set the time reference to Right, at a sweep speed of 5 ms, with a delay value of  $-80 \mu\text{s}$ , and you perform a single acquisition. The display would look like the following:

Figure 40

The time reference is set to Right  
The trigger point is off-screen to the right due to negative delay

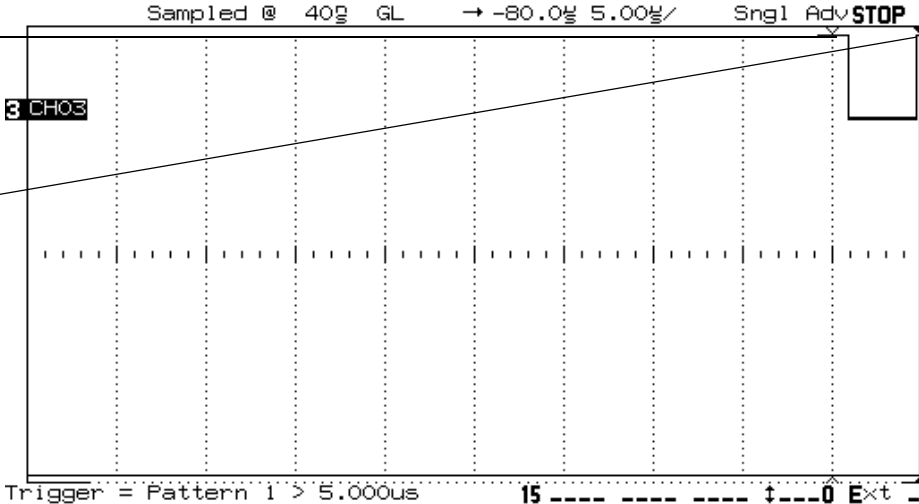

Single Acquisition, Time Reference Right, Negative Delay of  $80 \mu\text{s}$

The trigger point is off-screen to the right—that is why the solid triangle is at the right edge of the graticule. If you now stop and pan the display back by setting the delay to 0  $\mu\text{s}$ , the result looks like the following:

Figure 41

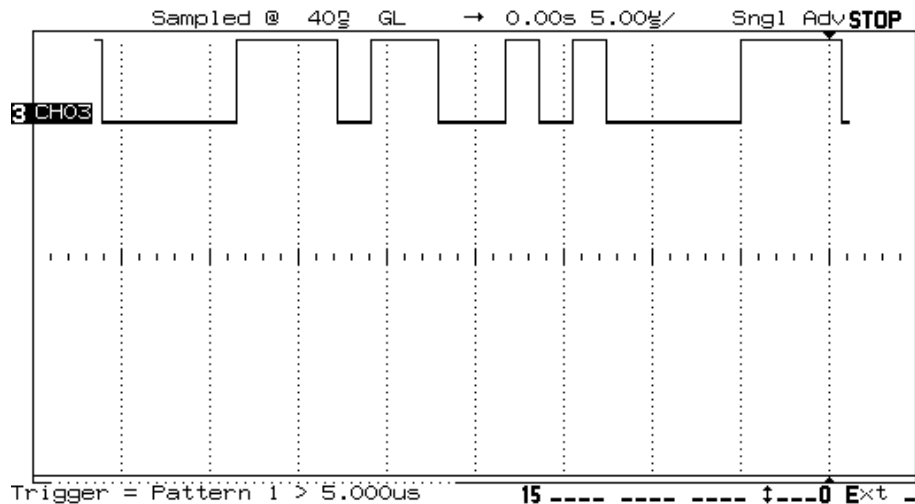

### Panning the Display to View the Trigger Point

Here, the trigger point is in memory. Note the memory bar position and that the delay value is 0. See chapter 7, “Performance Characteristics,” for more information on the specific limits available under delayed sweep.

### Measurement Functions

The analyzer’s single- and dual-channel measurement functions cannot be more accurate than the current sampling period. Suppose that you are trying to measure a skew value believed to be in the range of 5 to 10 ns, using the channel-to-channel delay function. If you have the sweep speed set to 5  $\mu\text{s}/\text{div}$ , the current sampling period is 40 ns. Thus, you will see a measurement result of either 0 ns or 40 ns, depending on where the waveform edges fall in relation to sampling.

The solution is to compare the current sample period against the expected measurement results, and change to lower Time/Div values (faster sweep speeds) if necessary to achieve the desired accuracy. In the example above, to accurately measure the value, you need to select a sweep speed of at least 500 ns/div or faster. Remember, however, that all measurements require that the events being measured be displayed on screen.

### **Varying the Time/Div Setting**

When you vary the Time/Div setting during Run mode, remember that the sample period is also being adjusted. If, for example, you rapidly change the Time/Div setting to a higher value (slower sweep speed), the sample period is also lengthened, and it will take longer to fill acquisition memory. Thus, there may be a short delay before a complete screen full of data is displayed.

## Probing the Circuit Under Test

You may encounter problems during your use of the HP 54620A/C that are related to probing. These problems fall into two categories: probe loading and probe grounding. Probe loading problems generally affect the circuit under test, while probe grounding problems affect the accuracy of the data to the measurement instrument. The design of the HP 54620A/C probes minimizes the first problem, while the second is easily addressed by good probing practices.

### Input Impedance

The probes used in the HP 54620A/C are passive probes, which offer high input impedance and high bandwidths. They usually provide some attenuation of the signal to the analyzer. This is typically 20 dB.

Passive probe input impedance is generally specified in terms of a parallel capacitance and resistance. The resistance is the sum of the tip resistor value and the input resistance of the test instrument (see figure 42). The capacitance is the series combination of the tip compensating capacitor and the cable plus instrument capacitance in parallel with the stray tip capacitance in parallel with the stray tip capacitance to ground. While this results in an input impedance specification that is an accurate model for DC and low frequencies, the high-frequency model of the probe input is more useful (see figure 43). This high-frequency model takes into account pure tip capacitance to ground as well as series tip resistance, and the cable's characteristic impedance ( $Z_0$ ).

Figure 42

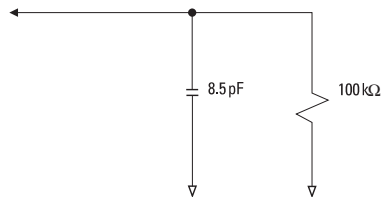

DC and Low-Frequency Probe Equivalent Circuit

Figure 43

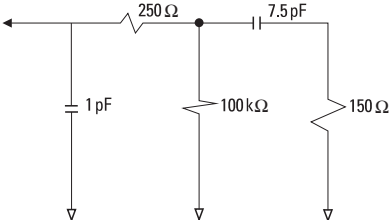

**High-Frequency Probe Equivalent Circuit**

The impedance plots for the two models are shown in figure 44. By comparing the two plots, you can see that both the series tip resistor and the cable’s characteristic impedance extend the input impedance significantly. The stray tip capacitance, which is generally small (1 pF), sets the final break point on the impedance chart.

Figure 44

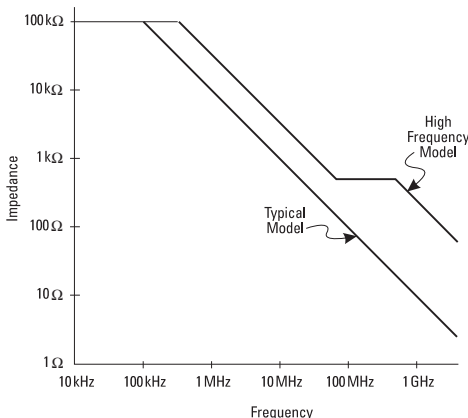

**Impedance versus Frequency for Both Probe Circuit Models**

The HP 54620A/C probes are represented by the high-frequency circuit model shown in figure 43. They are designed to provide as much series tip resistance as possible. Stray tip capacitance to ground is minimized by the proper mechanical design of the probe tip assembly. This provides the maximum input impedance at high frequencies.

### Probe Grounding

A probe ground is the low-impedance path for current to return to the source from the probe. Increased length in this path will, at high frequencies, create large common mode voltages at the probe input. The voltage generated behaves according to the equation:

$$V = L \frac{di}{dt}$$

Increasing the ground inductance ( $L$ ), increasing the current ( $di$ ) or decreasing the transition time ( $dt$ ), will all result in increasing the voltage ( $V$ ). When this voltage exceeds the threshold voltage defined in the logic analyzer, a false data measurement will occur.

Sharing one probe ground with many probes forces all the current that flows into each probe to return through the same common ground inductance of the probe whose ground return is used. See figure 45. The result is increased current ( $di$ ) in the above equation, and, depending on the transition time ( $dt$ ), the common mode voltage may increase to a level that causes false data generation.

Figure 45

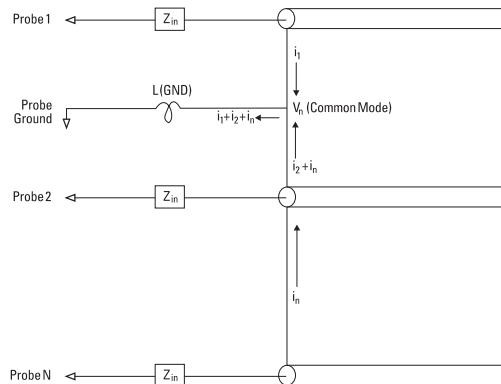

### Common Mode Input Voltage Model

In addition to the common mode voltage—*ground bounce*—longer ground returns also degrade the pulse fidelity of the probe system. Risettime is increased, and ringing, due to the undamped LC circuit at the input of the probe, is also increased. Because logic analyzers display reconstructed waveforms, they do not show ringing and perturbations. You will not find ground problems through examination of the waveform display. In fact, it is likely you will discover the problem through random glitches or inconsistent data measurements.

### **Best Probing Practices**

Because of the variables  $L$ ,  $di$ , and  $dt$ , you may be unsure how much margin is available in your measurement setup. The following are guidelines for good probing practices:

- The ground lead from each channel group (0-7 and 8-15) should be attached to the ground of the circuit under test if any channel within the group is being used for data capture.
- When capturing data in a noisy environment, every third probe's ground should be used in addition to the channel group's ground.
- High-speed timing measurements ( $T_R < 3$  ns) should make use of each probe's own ground.

When designing a high-speed digital system, you should consider designing dedicated test ports that interface directly to the instrument's probe system. This will ease measurement setup and ensure a repeatable method for obtaining test data.

---

## Glitch Detection

In digital system design, a *glitch* is an unintentional or unexpected signal transition, which may or may not pass through the logic threshold. The HP 54620A/C Logic Analyzer provides support for capturing glitches during acquisition. However, because the analyzer cannot determine whether the transition was valid, it defines the concept of a glitch differently. The analyzer considers a glitch to be any set of two or more edges that pass through the logic threshold and fall between logic analyzer samples.

### Why Glitch Capture?

When the analyzer is sampling at its maximum rate (2-ns sample period), all pulses within the bandwidth of the probes will be captured by the analyzer. As the sweep speed is decreased, the sample period is increased to make best use of acquisition memory. (See “Time base and Acquisition” in this chapter.) The longer sample period increases the probability that a pulse will fall between samples, and will therefore be missed.

To prevent missing these pulses, the analyzer automatically enables glitch capture once the Time/Div setting is 1  $\mu\text{s}/\text{div}$  or slower. Auto Glitch detection is disabled for time base settings where the sampling interval is 4 ns or faster. At these sweep speeds, the analyzer can reliably sample all signals that are within the bandwidth of its probing system, thus preventing aliases. In glitch capture, the analyzer uses memory resources to record an event where at least two transitions occurred between sample periods. (Those transitions must pass through the logic threshold.) Thus, because of the glitch capture circuitry, the analyzer can capture pulses as narrow as 3.5 ns.

### Glitch Display

Glitches displayed by the analyzer fall into one of four categories, depending on the relationship between input waveform events and acquisition samples. Figure 46 shows input waveforms and the resulting display for each of these categories.

In category 1, the pulse transitions high and then low between two samples. The reconstructed waveform simply shows this pulse as a glitch. In category 2, the pulse transitions high, low, then back to high again, and is still high when the next sample occurs. The reconstructed waveform shows the transition as a disjoint line, indicating that a glitch and some other transition occurred some time before the sample. Categories 3 and 4 are simply the inversions of categories 1 and 2.



**Glitch Detection**

If several transitions occur between samples, the analyzer displays only one glitch. Also, when multiple samples are mapped to a single display pixel—which is often the case—a display in category 2 or 4 will be the likely result, if any glitches occurred between those samples.

**Figure 46**

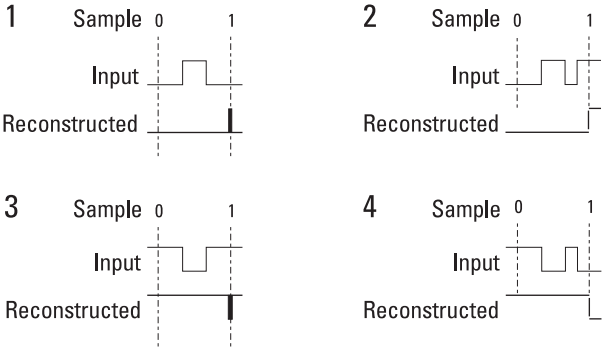

**Glitch Display**

**Aliasing and Glitch Capture**

In a sampled device, aliasing occurs when the same set of sampled data could be used to reconstruct many different waveforms, because of insufficient data. See figure 47, where, because of insufficient sampling rate, the reconstructed waveform would be only one-third the frequency of the original.

**Figure 47**

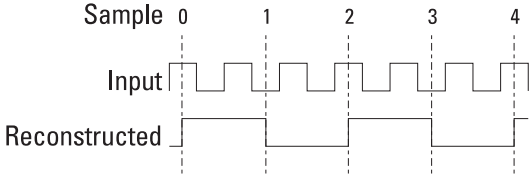

**Aliasing**

The HP 54620A/C glitch capture circuitry helps prevent aliasing by identifying additional transitions that occur between samples (for the HP 54620A/C, this is true when Auto Glitch Detect is on; when it is disabled, aliasing occurs). Figure 48 shows how the logic analyzer would reconstruct the waveform from figure 47, given the same sampling rate.

Figure 48

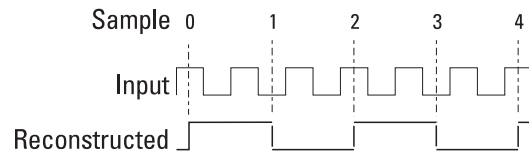

#### Reconstruction of Waveform with Glitch Capture

Notice that the analyzer identifies the other waveform events, though it cannot be as precise about the location and duration of those events as it could be with a faster sampling rate.

#### Choosing a Time base Setting

Because the Time/Div setting and the sampling rate are related, and because sampling rate determines the fidelity of reconstruction of the input waveform, you need to choose a Time/Div setting that will best represent the events on the input waveform. Usually, you will start with a setting that represents all the inputs you want to examine simultaneously. You can then examine the display and decide whether the sweep speed should be increased, based on the following:

- If the sampling rate is too slow compared to the number of waveform transitions, the display will show several glitches. You need to increase the sweep speed by at least a factor of two.
- If the sampling rate is much too slow compared to the number of waveform transitions, the displayed waveform will be a white bar. You need to increase the sweep speed by a factor of four to ten.

Figure 49 shows a waveform display with the main sweep as a solid bar, indicating that the sampling rate is too slow. The delayed sweep in the same display shows several glitches. Note the disjoint edges on other pulses, indicating that the analyzer detected the waveform to be in a different state after a glitch occurred.

Ensuring Accurate Measurements  
Glitch Detection

Figure 49

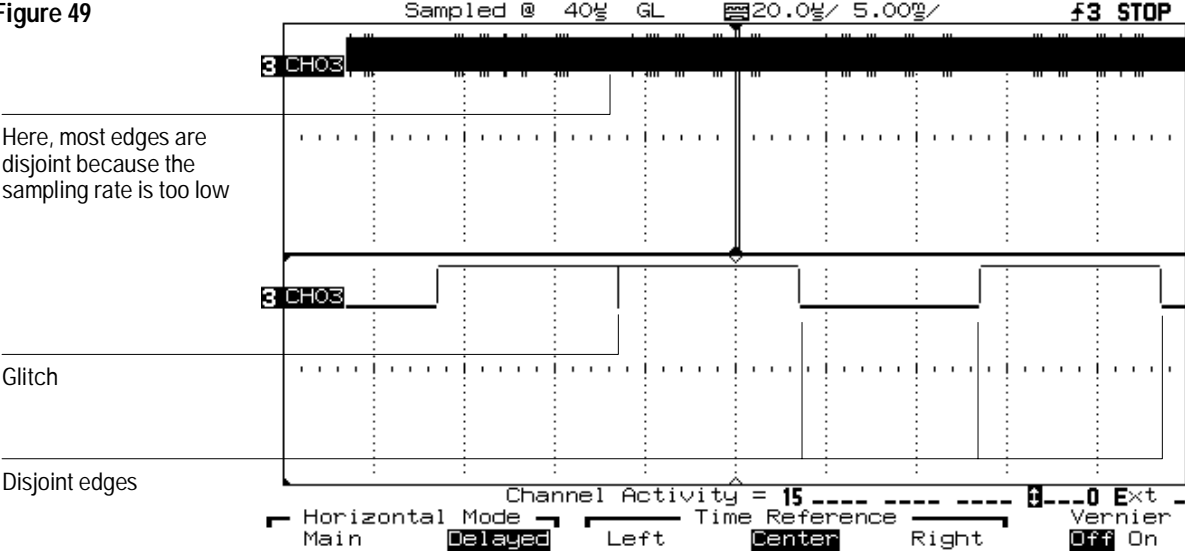

Waveform Display with Sampling Rate Too Low

Figure 50 shows the same waveform, this time captured at a much faster sweep speed and corresponding sampling rate. Notice that both the main and delayed sweeps show the waveform as a clearly defined series of pulses and that the disjoint waveform display has disappeared.

Figure 50

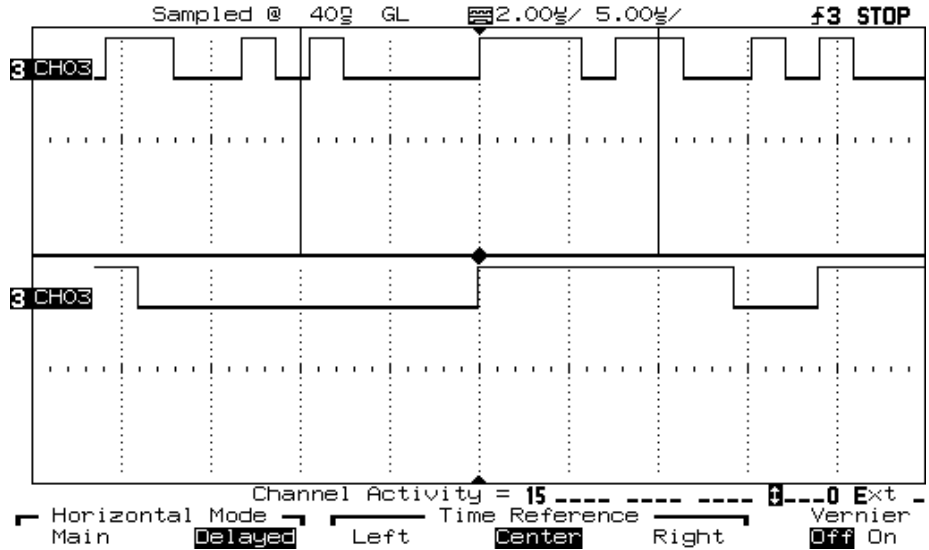

Waveform Display with Sufficient Sampling Rate

Another way to approach the choice of sampling rate is to consider the amount of margin designed into your system. Consider the following figure, which shows a composite data output from a state machine in relation to the system clock.

**Figure 51**

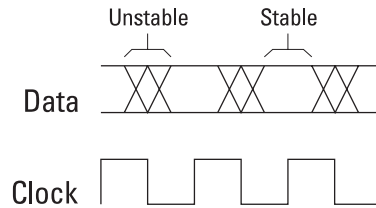

**Data Output Relative to Clock**

Here, we define the *margin* to be the ratio of the stable data time to unstable data time. If the system margin is large, a sampling rate that is 4 times the system clock rate is probably sufficient, but a sampling rate 10 times the system clock rate will deliver best results.

If the margin is small, you will need to increase the sampling rate to at least 10 to 20 times the system clock rate; this ensures that you will have enough data samples (3 or 4 during the stable data time) to determine whether your system is behaving correctly. (If the margin is too small, it is likely that the system works only intermittently or not at all.)

---

Testing, Adjusting, and  
Troubleshooting the Analyzer

---

## Testing, Adjusting, and Troubleshooting the Analyzer

This chapter explains the general procedures for verifying correct analyzer operation, adjusting the analyzer display and power supply, correcting malfunctions in the analyzer, and performing tests to ensure that the analyzer meets performance specifications.

---

## Testing the Analyzer

---

### **WARNING**

Hazardous voltages are on the CRT, power supply, and display sweep board. To avoid electrical shock, disconnect the power cord from the logic analyzer. Wait at least three minutes for the capacitors in the logic analyzer to discharge before you begin disassembling the logic analyzer. Read the Safety Summary at the back of this manual before beginning disassembly.

---

A set of built-in tests helps you verify general analyzer performance. These include the following:

- ROM and RAM self-tests
- Keyboard test
- Acquisition system test



## To perform self-tests

- 1 Press **Utility** .

Print and Utility are on the same key. A softkey menu appears at the bottom of the display.

- 2 Press **Self Tst Menu**.

- 3 Press **ROM**

The HP 54620A/C performs the ROM self test.

- 4 Press **RAM**.

The HP 54620A/C performs the RAM self test.

If either of these tests fail, it is likely that the system board is defective. See chapter 6, “Replaceable Parts,” for instructions on replacing the board. If your HP 54620A/C is under warranty, or you want to have HP perform the repair, contact your local Hewlett-Packard Sales Office.

- 5 Press **Previous Menu** to return to the Print/Utility menu, or press any other front-panel key to select a different function.

### Self-Tests when using HP 54652B and HP 54659B Modules

When using the HP 54652 and HP 54659 “B-series” modules, you must press the Service Menu softkey after Utility to enter the self-tests.

---

## To test the keyboard

- 1 Press **Utility** .

Print and Utility are on the same key. A softkey menu appears at the bottom of the display.

- 2 Press **Self Tst Menu**.

- 3 Press **Keyboard**.

- a Press each key on the front panel.

A key is responding correctly if the corresponding rectangle on the display is filled in.

- b Turn each knob on the front panel in both directions.

The knob is responding correctly if a bidirectional arrow appears in the corresponding circle on the front panel.

- 4 When the **Run/Stop** key has been pressed three times, the test will exit.

If any of the keys fail, you must replace the keyboard. See chapter 6, “Replaceable Parts,” for instructions. If your HP 54620A/C is under warranty, or you want to have HP perform the repair, contact your local Hewlett-Packard Sales Office.

### Keyboard Tests when using HP 54652B and HP 54659B Modules

When using the HP 54652 and HP 54659 "B-series" modules, you must press the Service Menu softkey after Utility to enter the keyboard tests.

## To test the display

- 1 Press **Utility** .
- 2 Press **Self Tst Menu**.
- 3 Press **Display**.

The analyzer will prompt you to press any key to continue through the test. If any of the tests fail, you must replace the display. See chapter 6, “Replaceable Parts,” for instructions. If your HP 54620A/C is under warranty, or you want to have HP perform the repair, contact your local Hewlett-Packard Sales Office.

### Display Tests when using HP 54652B and HP 54659B Modules

When using the HP 54652 and HP 54659 “B-series” modules, you must press the Service Menu softkey after Utility to enter the display tests.

---

## To test the acquisition system

Testing the acquisition system does not check a specification, but does provide confidence that the system is functioning correctly.

- 1 Disconnect probes from the circuit under test or other input source.
- 2 Connect channels 0, 1, 2, and 3 to the calibration test point on the HP 54620A/C front panel, using probe leads and grabbers.
- 3 Press **Autoscale** .

If four square waves appear, the acquisition system is functioning correctly.

- 4 Repeat steps 2 and 3 with the following sets of channels.
  - 4, 5, 6, 7
  - 8, 9, 10, 11
  - 12, 13, 14, 15

Be sure to disconnect each set of channels from the calibration test point before connecting the next.

---

## Building Test Accessories

To completely test and troubleshoot the analyzer, you will need to fabricate two test accessories:

- The test connectors make it easy to hook the analyzer probes to function generators and measurement equipment with minimum electrical distortion. These connectors are used in the threshold and time interval tests.
- The dummy load is used to troubleshoot the power supply.

This section explains how to build these accessories.

---

## To make the test connectors

The test connectors connect the logic analyzer to the test equipment.

Table 8

---

### Materials Required

---

Description	Recommended Part	Qty
BNC (f) Connector	HP 1250-1032	2
Berg Strip, 8-by-2		1
Berg Strip, 1-by-2		1
100 $\Omega$ 1% resistor	HP 0698-7212	2
Jumper wire		

- 1** Build the first test connector using a BNC connector and an 8-by-2 section of Berg strip.
  - a** Solder a jumper wire to all pins on one side of the Berg strip.
  - b** Solder a jumper wire to all pins on the other side of the Berg strip.
  - c** Solder the center of the BNC connector to the center pin of one row on the Berg strip.
  - d** Solder the ground tab of the BNC connector to the center pin of the other row on the Berg strip.

Figure 52

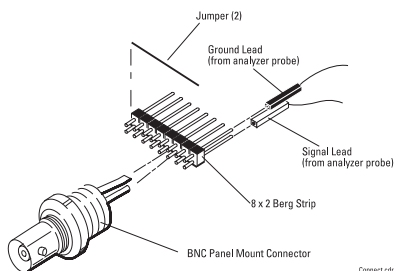

### 8-by-2 Connector Setup

- 2 Build the second test connector using a BNC connector and a 1-by-2 section of Berg strip.
  - a Solder two resistors to the Berg strip, in parallel across the two pins.
  - b Solder the center of the BNC connector to the center pin of one row on the Berg strip.
  - c Solder the ground tab of the BNC connector to the center pin of the other row on the Berg strip.

Figure 53

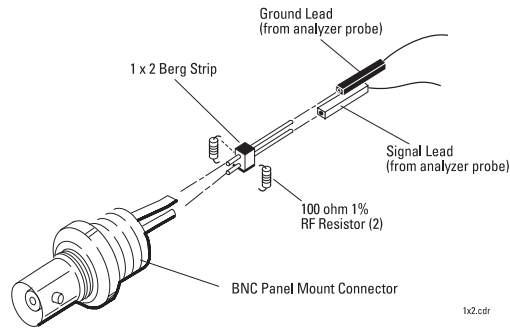

1-by-2 Connector Setup

## To make the dummy load

You can build the dummy load for the power supply, or purchase it from Hewlett-Packard using HP P/N 54600-66504. HP 54600-66504 consists of a cable, HP P/N 8120-1506, and a test connector, HP P/N 1251-6981.

- 1** Obtain a connector compatible with the connector on the LVPS.
- 2** Connect the following load resistors to the connector.
  - +5.1 V requires a 3 A load, 1.7  $\Omega$  and 15 W on pin 15, 17, or 19.
  - +15.75 V requires a 1.3 A load, 12.2  $\Omega$  and 20.5 W on pin 11 or 13.
  - With the fan operating, -15.75 V requires a 0.6 A load, 26.25  $\Omega$  and 9.5 W on pin 5 or 7.
  - Without the fan operating, -15.75 V requires a 0.8 A load, 26.25  $\Omega$  and 13 W on pin 5 or 7.
- 3** Connect the other end of the resistors to ground pins 2, 4, 6, and 8.

---

## Adjusting the Logic Analyzer

This section explains how to adjust the logic analyzer so that it is at optimum operating performance. You need to perform the adjustments every 24 months or 4000 hours of operation.

Make sure you allow the logic analyzer to warm up for at least 30 minutes before you start the adjustments.



**To adjust the power supply**

---

**To adjust the power supply**

---

**WARNING**

The maintenance described in this section is performed with power supplied to the logic analyzer and with the protective covers removed. Only trained service personnel who are aware of the hazards involved should perform the maintenance. Whenever possible, perform the procedures with the power cord removed from the logic analyzer. Read the safety summary at the back of this book before proceeding.

---

On the power supply there is only one adjustment, which is for the +5.1 V supply. The other voltages are based on the +5.1 V adjustment. In this procedure you use a multimeter to measure the +5.1 V, and, if necessary, adjust the supply to within tolerance.

**Table 9**

---

**Equipment Required**

Equipment	Critical specifications	Recommended Model/Part
Digital multimeter	0.1 mV resolution, accuracy ±0.05%	HP 34401A

- 1** Set up the logic analyzer for the voltage adjustment.
  - a** Turn off the logic analyzer.
  - b** Remove the cover from the logic analyzer.  
See chapter 6, “Replaceable Parts,” for disassembly procedures.
  - c** Place the logic analyzer on its side.
  - d** Connect the negative lead of the digital multimeter to a ground point on the logic analyzer.
  - e** Turn on the logic analyzer.

**2 Measure the power supply voltages at L1, L2, and L3 on the system board.**

Make sure that the voltage measurements are within the following tolerances.

+5.1 V	$\pm 150$ mV (+4.95 V to +5.25 V)
+15.75 V	$\pm 787$ mV (+14.96 V to +16.54 V)
-15.75 V	$\pm 787$ mV (-14.96 V to -16.54 V)

If the +5.1 V measurement is out of tolerance, adjust the +5.1 V adjustment on the power supply. The  $\pm 15.75$  V supplies are not adjustable and are dependent upon the +5.1 V supply. If adjusting the power supply does not bring all the voltages within tolerance, see “Troubleshooting the Logic Analyzer” in this chapter.

Figure 54

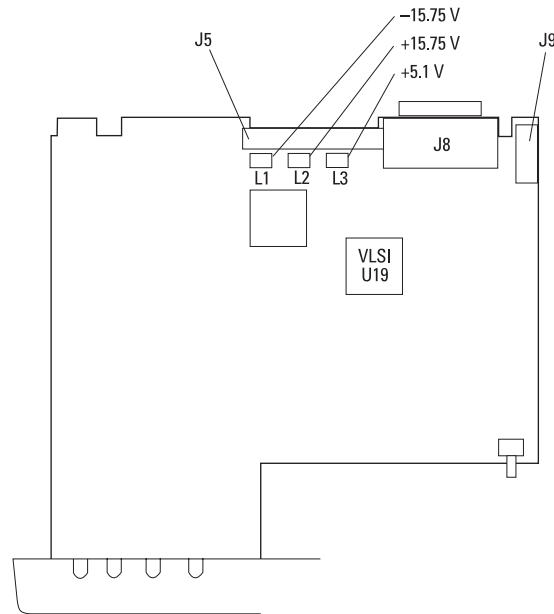

Power Supply Adjustment

---

## To adjust the display (HP 54620A only)

---

### WARNING

The maintenance described in this section is performed with power supplied to the logic analyzer and with the protective covers removed. Only trained service personnel who are aware of the hazards involved should perform the maintenance. Whenever possible, perform the procedures with the power cord removed from the logic analyzer. Read the safety summary at the back of this book before proceeding.

The display does not normally need adjustment. You should use this procedure only for the few cases when the display is obviously out of adjustment.

---

Table 10

### Equipment Required

---

Equipment	Critical specifications	Recommended Model/Part
Digital multimeter	1 mV resolution, accuracy ±0.05%	HP 34401A

- 1 Set up the logic analyzer for the voltage adjustment.
  - a Turn off the logic analyzer.
  - b Remove the cover from the logic analyzer.  
See chapter 6, "Replaceable Parts," for disassembly procedures.
  - c Place the logic analyzer on its side.
  - d Connect the negative lead of the digital multimeter to a ground point on the logic analyzer.
  - e Turn on the logic analyzer.
- 2 Connect the digital multimeter to the end of R901 closest to the fuse. See figure 55.
- 3 Adjust +B for +14.00 V.
- 4 Press Print/Utility . Press **Self Tst Menu**, then **Display**.  
  
If the HP 54620C display test fails, you must replace the display. See "To test the display" in this chapter.
- 5 Adjust V.HO (vertical hold) for vertical synchronization.
- 6 Set the intensity control (on the front panel) to mid-range.

- 7 Adjust Sub Bri (sub bright) to the lowest setting so that the half-bright blocks on the display are visible.
- 8 Increase the intensity control to a comfortable viewing level.  
This is usually about 3/4 of its maximum range.
- 9 Adjust HB Cont (half-bright contrast) for the best contrast between the half-bright and full-bright blocks.  
You can re-adjust Sub Bri, intensity control, and HB Cont to suit your individual preference.
- 10 Press any key to continue to the next test pattern. Then, adjust H.Hold (horizontal hold) to center the display horizontally.
- 11 Adjust Focus for the best focus.
- 12 Press any key to continue to the normal display pattern. Then adjust V.Lin (vertical linearity) for equal sizing of all four corner squares.
- 13 Adjust V.Size (vertical size) to center the display vertically at the maximum allowable size without losing the text.  
Adjustments V.Lin and V.Size interact so you may need to re-adjust sizing and vertical centering of the display.

Figure 55

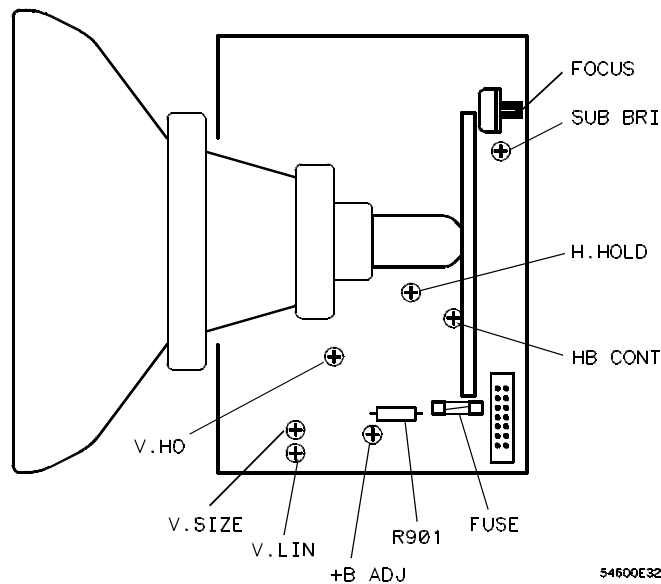

### Display Adjustment

---

# Troubleshooting the Logic Analyzer

The service policy for this instrument is replacement of defective assemblies. The following procedures can help isolate problems to the defective assembly.

---

**WARNING**

---

The maintenance described in this section is performed with power supplied to the logic analyzer and with the protective covers removed. Only trained service personnel who are aware of the hazards involved should perform the maintenance. Whenever possible, perform the procedures with the power cord removed from the logic analyzer. Read the safety summary at the back of this book before proceeding.

---

**CAUTION**

---

Do not disconnect any cables or remove any assemblies with the power applied to the logic analyzer, or damage to the logic analyzer can occur.

The following equipment is needed to troubleshoot the logic analyzer.

Table 11

---

**Equipment Required**

---

Equipment	Critical specifications	Recommended model/part
Digital multimeter	1 mV resolution, accuracy $\pm 0.05\%$	HP 34401A
Oscilloscope	100 MHz	HP 54600
Probe	10:1 division ratio	HP 10071A
Dummy load	Compatible with power supply	HP 54600-66504

## To troubleshoot the logic analyzer

- 1** Ensure that the analyzer is connected to a live power source.  
If not, connect to a live power source and turn on the analyzer. If the symptoms recur, go to step 2.
- 2** Is there an interface module connected to the logic analyzer?  
If yes, do the following steps. If not, go to step 3.
  - a** Turn off the logic analyzer.
  - b** Remove the module.
  - c** Turn on the logic analyzer, then check for the failing symptom.  
If the failing symptom disappears, replace the module. If not, go to step 3.
- 3** Disconnect any external cables from the front panel.
- 4** Disconnect the power cord, then remove the cover.  
See chapter 6, “Replaceable Parts,” for disassembly procedures.
- 5** Connect the power cord, then turn on the logic analyzer.  
If the display comes on after a few seconds, (HP logo and copyright text, followed by a graticule with text at top of the display) go to “To check the LVPS.” If after checking the LVPS the voltages are within the test limits, go to step 9. If not, go to step 7. If the display did not come on, do the steps below.
  - a** Check the intensity knob to verify whether the setting is too low.
  - b** If there is still no display, disconnect the power cord.
  - c** Check all cable connections.
  - d** Go to “To check the LVPS.”  
If the voltages are within the limits go to step 6. If not, go to step 7.

- 6** Disconnect the display cable, then check the following signals on the system board, using an oscilloscope.

Table 12

---

**Display Signals**

---

**HP 54620A Logic Analyzer**

	<b>Signal</b>	<b>Frequency</b>	<b>Pulse width</b>	<b>Voltage</b>
U3 Pin 7	DE	19.72 kHz	38.0 $\mu$ s	2.6 Vp-p
U3 Pin 24	Hsync	19.72 kHz	3.0 $\mu$ s	5.0 Vp-p
U4 Pin 2	CTD_Sync	60.00 Hz	50 ns	5.0 Vp-p

**HP 54620C Color Logic Analyzer**

	<b>Signal</b>	<b>Frequency</b>	<b>Pulse width</b>	<b>Voltage</b>
U34 Pin 18	DE	16.67 kHz	48.0 $\mu$ s	5.0 Vp-p
U 39 Pin 21	Hsync	16.67 kHz	2.9 $\mu$ s	5.0 Vp-p
U 34 Pin 2	CTD_Sync	50.0 Hz	60.0 ns	5.0 Vp-p

If the signals are good, replace the display assembly. If not, replace the system board.

- 7** Disconnect the LVPS ribbon cable from the display board.

- 8** Measure the power supply voltages again (steps 2-4).

If the voltages are within the test limits, replace the display assembly. If not, do the steps below.

- a** Disconnect the power cord.
- b** Disconnect the ribbon cable from the power supply.
- c** Connect the dummy load to the power supply connector.
- d** Connect the power cord, then measure the power supply voltages again, using a voltmeter (see new tolerances below).

+5.1 V (4.95 V to +5.25 V)

+15.75 V (+15 V to +16.5 V)

-15.75 V (-15 V to -16.5 V)

If the voltages are now within the test limits, replace the system board. If not, replace the power supply.

**9 Is the fan running?**

If yes, go to “To perform self-tests.” If not, do the steps below.

The LVPS has a thermal cut-out circuit. If the fan is defective, the LVPS shuts down when it gets too hot for safe operation.

- a** Disconnect the fan cable from the power supply.
- b** Measure the fan voltage at the connector on the power supply, using a voltmeter.

If the fan voltage is less than  $-5.0$  Vdc, replace the fan. If not, replace the power supply.



## To check the LVPS

- 1 Disconnect the power cord, then set the logic analyzer on its side.
- 2 Connect the negative lead of the multimeter to a ground point on the logic analyzer. Connect the power cord and turn on the logic analyzer.
- 3 Measure the power supply voltages at L1, L2, and L3 on the system board, using a voltmeter. See "To adjust the power supply" in this chapter.

+5.1 V	$\pm 150$ mV (+4.95 V to +5.25 V)
+15.75 V	$\pm 787$ mV (+14.96 V to +16.54 V)
- 15.75 V	$\pm 787$ mV (-14.96 V to -16.54 V)

If the +5.1 V measurement is out of the test limits, adjust the +5.1 V power supply. The  $\pm 15$  V supplies are not adjustable; they depend upon the +5.1 V supply.

### Blown Fuse

If the fuse is blown in the power supply, the power supply is defective. Replace the power supply.

---

## Testing Threshold Accuracy

Testing the threshold accuracy verifies the data channel threshold accuracy specification. You should perform this test every 24 months or 4000 hours of operation, whichever comes first.

These instructions include detailed steps for testing the threshold settings of channels 0-7. After testing channels 0-7, connect and test channels 8-15, then the external trigger input. Use the detailed steps for channels 0-7, substituting channels 8-15 or external trigger for channels 0-7 in the instructions.

Each threshold test tells you to record the voltage reading in the Performance Test Record located at the end of this chapter. To check if each test passed, verify that the voltage reading you record is within the limits listed on the Performance Test Record.

**Table 13**

---

### Equipment Required

---

<b>Equipment</b>	<b>Critical Specifications</b>	<b>Recommended Model/Part</b>
Digital Multimeter	0.1 mV resolution, 0.005% accuracy	HP 34401A
Function Generator	DC offset voltage $\pm 6.3$ V	HP 3325B Option 002
BNC-Banana Cable		HP 11001-60001
BNC Tee		HP 1250-0781
BNC Cable		HP 10503A
BNC Test Connector, 8-by-2		

## **Step 1. To set up the equipment**

- 1** Turn on the test equipment and the logic analyzer. Let them warm up for 30 minutes before beginning the test.
- 2** Set up the function generator.
  - a** Set up the function generator to provide a DC offset voltage at the Main Signal output.
  - b** Disable any AC voltage to the function generator output, and enable the high voltage output.
  - c** Monitor the function generator DC output voltage with the multimeter.



---

### Step 3. To test the thresholds

- 1 Press `Logic levels`. Select **Chan 0-7**, under the **set** softkey, then select the **User** softkey under **Logic Thresholds**.
- 2 For each of the threshold levels shown in the following table, take the following steps:
  - a Use the Entry knob on the logic analyzer to select the threshold voltage shown in the table.
  - b On the function generator front panel, enter the DC offset voltage shown in the table. Use the multimeter to verify the voltage.  
The activity indicators for channels 0-7 should show all data channels at a logic high.
  - c Using the Modify down arrow on the function generator, decrease offset voltage in 10-mV increments until all activity indicators for channels 0-7 show the channels at a logic low. Record the function generator voltage in the performance test record.
  - d Using the Modify up arrow on the function generator, increase offset voltage in 10-mV increments until all activity indicators for channels 0-7 show the channels at a logic high. Record the function generator voltage in the performance test record.
- 3 Using the 8-by-2 test connector, connect channels 8-15 to the output of the function generator.
- 4 Repeat steps 1 and 2, substituting channels 8-15 for channels 0-7.
- 5 Repeat steps 1 and 2 for the external trigger input, using the 8-by-2 test connector, and substituting the external trigger input for channels 0-7 in the threshold menus.

Table 14

---

**Threshold Test Settings**

---

Threshold Voltage	DC Offset Voltage
+5.0	+5.252 V $\pm$ 1 mV DC
-5.0	-4.748 V $\pm$ 1 mV DC
0.0	+0.102 V $\pm$ 1 mV DC

---

---

## Testing Time Interval Accuracy

Testing the time interval accuracy does not check a specification, but does verify proper operation of the 125-MHz oscillator.

This test verifies that the 125-MHz timing acquisition synchronizing oscillator is operating within limits.

Table 15

---

### Equipment Required

---

Equipment	Critical Specifications	Recommended Model/Part
Time Mark Generator	Rise time < 10 ns; device under test error is indicated to within one least significant digit	Tektronix TG 501A or equivalent
Oscilloscope	100 MHz bandwidth	HP 54600
BNC Tee		HP 1250-0781
BNC Cable (Qty 2)		HP 10503A
BNC Test Connector, 1x2		

---

## Step 1. To connect the logic analyzer

- 1 Using the 1-by-2 test connector and a BNC cable assembly, connect channel 0 to one side of the BNC Tee.
- 2 Using a second BNC cable, connect the oscilloscope to the other side of the BNC Tee.
- 3 Connect the BNC Tee to the Mark output of the time mark generator.

Figure 57

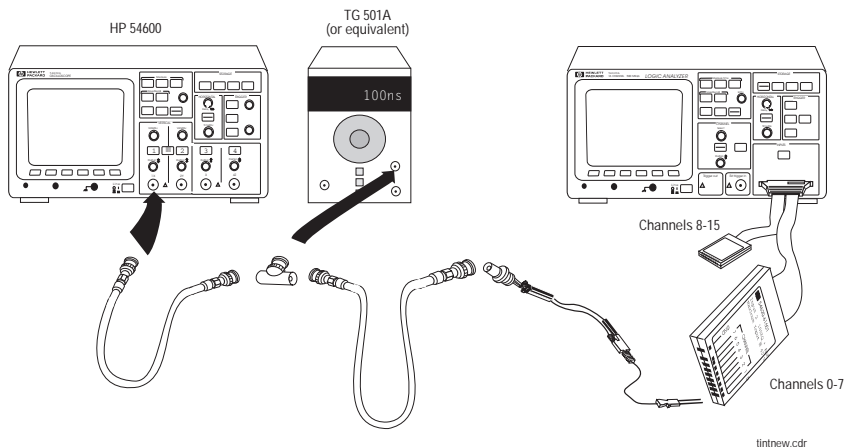

Time Interval Accuracy Setup

## Step 2. To set up the equipment

- 1** Turn on the test equipment and the logic analyzer. Let them warm up for 30 minutes if you have not already done so.
- 2** Set the time mark generator for a mark output of 100 ns.
- 3** Press  on the oscilloscope.

If you are not using an HP 54600-Series oscilloscope, adjust the oscilloscope to achieve the best waveform display.

- 4** Measure the high and low output levels (in dc volts) of the mark generator by reading them from the oscilloscope display.

You will need these values when setting the threshold level for the logic analyzer.



### Step 3. To set up the logic analyzer

- 1 Press `Autoscale` .
- 2 Press `Logic levels` .
- 3 Press the **Set** softkey to select **Chan 0-7**.
- 4 Press the **User** softkey, then use the Entry knob to set the threshold voltage to the 50% level of the mark generator pulse, based on the voltages you measured previously.
- 5 Set the Time/div knob to 20 ns/div.

---

## Step 4. To make the measurement

**1** Press `Single channel` .

**2** Press `Period`.

The mark period should be  $100 \text{ ns} \pm 2 \text{ ns}$ . Record the results in the Performance Test Record.

**Performance Test Record  
HP 54620A/C \_\_\_\_\_**

Serial No. \_\_\_\_\_

Work Order No. \_\_\_\_\_

Recommended Test Interval - 2 Years/4000 hours

Date \_\_\_\_\_

Recommended next testing \_\_\_\_\_

Temperature \_\_\_\_\_

Test	Settings	Results				
<b>Threshold Accuracy</b>	$\pm$ (100 mV + 3% of threshold setting)	Limits	Ch. 0-7	Ch. 8-15	Ext. Trig.	
	-User, $\pm$ 250 mV	-User $V_L$	-5.250 V	_____	_____	_____
		- User $V_H$	-4.750 V	_____	_____	_____
	+ User, $\pm$ 250 mV	+ User $V_L$	+4.750 V	_____	_____	_____
		+ User $V_H$	+5.250 V	_____	_____	_____
	0 V, $\pm$ 100 mV	0 V User $V_L$	-100 mV	_____	_____	_____
	0 V User $V_H$	+100 mV	_____	_____	_____	
Test	Settings	Results				
<b>Time Interval Accuracy</b>		Measured				
	Limit	100 ns $\pm$ 2 ns				



## Replaceable Parts

---

## Replaceable Parts

This chapter contains instructions for removing and ordering replaceable assemblies. Also in this section is a parts list for the assemblies and hardware of the logic analyzer that you can order from Hewlett-Packard.

If you need a component for one of the printed circuit boards, refer to the parts list included with the component information packet for this logic analyzer. For more information on these packets, contact your nearest Hewlett-Packard Sales Office.

---

## Removing and Replacing Assemblies

---

**WARNING**

Hazardous voltages are on the CRT, power supply, and display sweep board. To avoid electrical shock, disconnect the power cord from the logic analyzer. Wait at least three minutes for the capacitors in the logic analyzer to discharge before you begin disassembling the logic analyzer. Read the Safety Summary at the back of this manual before beginning disassembly.

---

**CAUTION**

Do not replace assemblies with the logic analyzer turned on, or damage to the components can occur.

Refer to the exploded view of the logic analyzer, figure 60, for details on how the logic analyzer fits together. To install an assembly, follow the instructions in reverse order.

You will need the following tools to disassemble the logic analyzer:

- T15 TORX driver to remove the logic analyzer from the cabinet and to remove the fan.
- T10 TORX driver to remove the assemblies from the deck.
- Flat-blade screwdriver to remove the front panel and power shaft and the optional interface modules and pouch.

You can remove any of the following seven assemblies: fan, front panel, display, system board, power supply, keyboard, and handle.

---

## To remove the cabinet

- 1** Turn off the logic analyzer and disconnect the power cable.
- 2** If a module is installed, remove it from the logic analyzer.
- 3** Using the T15 TORX driver, remove the two screws from the rear of the cabinet.
- 4** Using your thumbs, gently push on the rear-panel connector to slide the logic analyzer out of the cabinet.

---

## To remove the fan

- 1** Disconnect the fan cable from the power supply board.
- 2** Using the T15 TORX driver, remove the three screws that hold the fan to the deck.



---

## To remove the front panel

- 1 Remove the intensity knob by pulling straight out.
- 2 Disconnect the keyboard ribbon cable from the system board.
- 3 Use a screwdriver to release retainer tab A, and your finger to release retainer tab B. See figure 58.

### Releasing front panel from deck of instrument

When tab B is released, be careful that the sheet metal tab of front-panel ground input clears the softkey circuit board. The circuit board may be depressed slightly with a screwdriver to avoid damage to the circuit board.

- 4 Rotate the front panel out until the bottom clears the rear of the assembly, then lift the front panel to free the hooks on top.

When installing the front panel, make sure that the power switch shaft is aligned with its mating hole in the front panel.

The front panel swings in to engage the two retainer tabs. Before attempting to engage the retainer tabs, make sure that the six hooks on top of the front panel are fully engaged with their mating holes in the sheet metal.

Figure 58

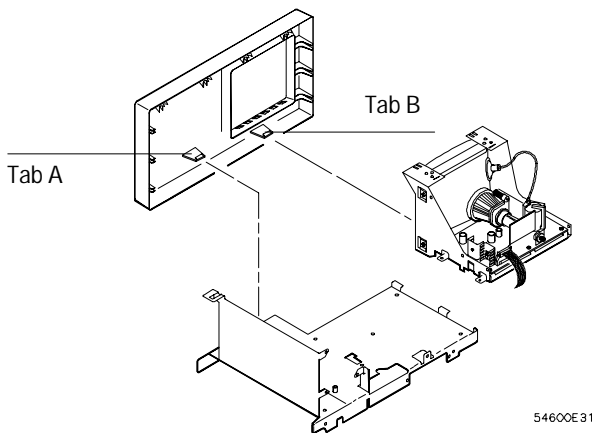

Front Panel Removal

---

## To remove the display

- 1 Remove the front panel on the HP 54620A/C.
- 2 Disconnect the ribbon cable and the calibration cable from the display.
- 3 Using the T10 TORX driver, remove the two screws that hold the display to the deck.  
Make sure that when you re-install these screws that you use the correct parts. If longer screws are used, they can short the system board to ground.
- 4 As you lift the display, rotate it off the two tabs on the side of the deck.

---

## To remove the system board

- 1** Using the T10 TORX driver, remove the eight screws that hold the system board to the deck.
- 2** Remove the two screws from the rear-panel interface connector.
- 3** Disconnect the three ribbon cables and the calibration cable.
- 4** As you remove the system board, rotate the system board so that the BNCs clear the front panel.

---

## To remove the power supply

- 1 Remove the fan.
- 2 Disconnect the ground wire (green wire with the yellow stripe) from the deck.
- 3 Disconnect the ribbon cable from the power supply board.
- 4 Use a screw driver to gently unhook the latch that holds the white shaft to the power switch, then disconnect the shaft from the power switch. After you disconnect the shaft, make sure you position it in the recess along the side of the display bracket.
- 5 Using the T10 TORX driver, remove the screw holding the power supply board to the deck.
- 6 Slide the power supply board towards the front panel about a half an inch. Slip the keyhole slots on the power supply board off of the pins on the deck.

Figure 59

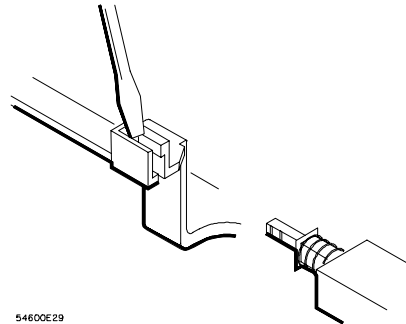

Unhooking the Power Switch Shaft

## To remove the keyboard

- 1** Remove the front panel.
- 2** Remove all the knobs by pulling straight out.
- 3** Flex the bezel of the front panel to unsnap the small keyboard under the display opening.
- 4** Using the T10 TORX driver, remove the three screws from the large keyboard.  
Make sure that when you reinstall these screws that you use the correct parts. If longer screws are used, they can damage the front-panel label.
- 5** Press down on the top of the keyboard, and rotate the bottom of the keyboard out.

---

## To remove the handle

- Rotate the handle down until it is just past the last detent position (about 1/2 inch before the handle touches the bottom of the logic analyzer), then pull the sides of the handle out of the cabinet.

---

## Replaceable Parts

The system board is part of an exchange program with Hewlett-Packard. The exchange program allows you to exchange a faulty assembly with one that has been repaired and performance verified by Hewlett-Packard.

After you receive the exchange assembly, return the defective assembly to Hewlett-Packard. A United States customer has 30 days to return the defective assembly. If you do not return the faulty assembly within the 30 days, Hewlett-Packard will charge you an additional amount. This amount is the difference in price between a new assembly and that of the exchange assembly. For orders not originating in the United States, contact your nearest Hewlett-Packard Sales Office for information.

---

## To order a replacement part

- To order a part in the material list, quote the Hewlett-Packard part number, indicate the quantity desired, and address the order to your nearest Hewlett-Packard Sales Office.
- To order a part not listed in the material list, include the model number and serial number of the logic analyzer, a description of the part (including its function), and the number of parts required. Address the order to your nearest Hewlett-Packard Sales Office.
- To order using the direct mail order system, contact your nearest Hewlett-Packard Sales Office.

Within the USA, Hewlett-Packard can supply parts through a direct mail order system. The advantages to the system are direct ordering and shipment from the HP Parts Center in Mountain View, California. There is no maximum or minimum on any mail order. (There is a minimum amount for parts ordered through a local Hewlett-Packard Sales Office when the orders require billing and invoicing.) Transportation costs are prepaid (there is a small handling charge for each order) and there are no invoices.

For Hewlett-Packard to provide these advantages, a check or money order must accompany each order. Mail-order forms and specific ordering information are available through your local Hewlett-Packard Sales Office. Addresses and telephone numbers are located in a separate document shipped with the instrument.



Replaceable Parts  
 To order a replacement part

Figure 60

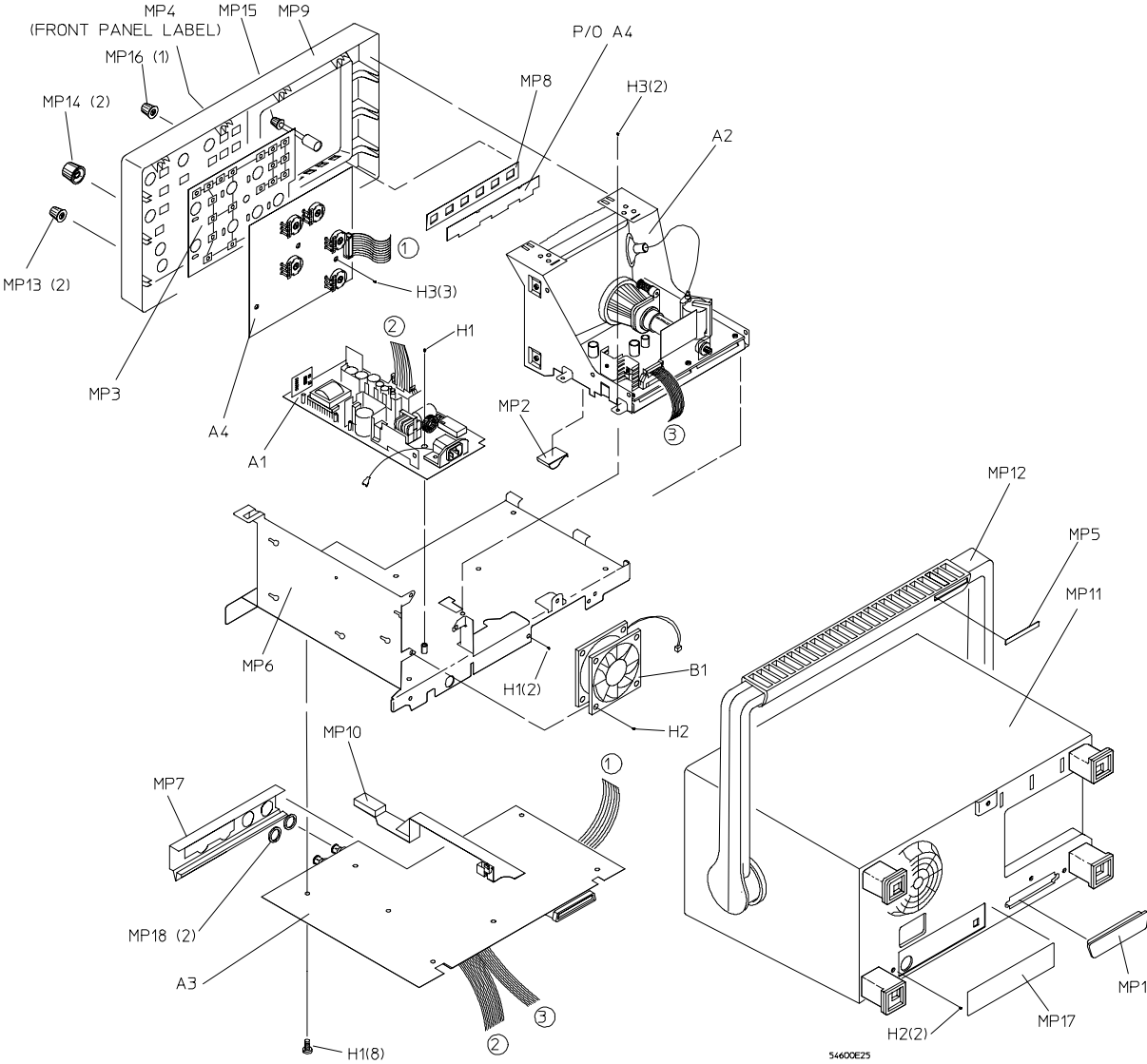

Exploded View of Logic Analyzer

Table 16

HP 54620A/C Replaceable Parts

Reference Designator	HP Part Number	Qty	Description
A1	0950-2125	1	Power supply assembly
A2 (HP 54620A)	2090-0316	1	Display assembly
A2 (HP 54620C)	54620-68801	1	Display assembly
A2 (HP 54620C)	54620-69801	1	Exchange display assembly
A3 (HP 54620A)	54620-66501	1	System board
A3 (HP 54620A)	54620-69501	1	Exchange system board
A3 (HP 54620C)	54620-66503	1	System board
A3 (HP 54620C)	54620-69503	1	Exchange system board
A4	54620-66502	1	Keyboard
B1	3160-0619	1	Fan
H1	0515-0372	11	Machine screw M3 X 8
H2	0515-0380	5	Machine screw M4 X 10
H3	0515-0430	5	Machine screw M3 X 6
MP1	1251-2485	1	Connector dust cover
MP2	1400-1581	1	Cable clamp
MP3	54620-41901	1	Large keypad
MP4 (HP 54620A)	54620-94301	1	Front-panel label
MP4 (HP 54620C)	54620-94306	1	Front-panel label
MP5 (HP 54620A)	54620-94302	1	Handle Label
MP5 (HP 54620C)	54620-94307	1	Handle Label
MP6	54601-00102	1	Deck
MP7	54620-07101	1	EMI gasket
MP8	54601-41902	1	Small rubber keypad
MP9	54601-42201	1	Front panel
MP10	54601-43701	1	Power-switch shaft
MP11	54601-64401	1	Cabinet (comes with handle and feet installed)
MP12	54601-44901	1	Handle
MP13	54601-47401	2	Small knob
MP14	54601-47402	2	Large knob
MP15	54601-47403	1	Intensity knob
MP16	54601-47404	1	Small knob (dark)

Replaceable Parts  
**To order a replacement part**

Reference Designator	HP Part Number	Qty	Description
MP17	54620-94303	1	Rear-panel label
MP18	54620-21701	2	BNC bushing
W1	8120-1521	1	Standard power cord
W1	8120-1703		Power cord option 900, United Kingdom
W1	8120-0696		Power cord option 901, Australia
W1	8120-1692		Power cord option 902, Europe
W1	8120-0698		Power cord option 904, 250 V, USA/Canada
W1	8120-2296		Power cord option 906, Switzerland
W1	8120-2957		Power cord option 912, Denmark
W1	8120-4600		Power cord option 917, Africa
W1	8120-4754		Power cord option 918, Japan
	54620-61602	1	Display Cable (HP 54620C)
	54620-61603	1	Power Supply Cable (HP 54620C)
	<b>Option 101</b>		<b>Accessory pouch and front-panel cover (also orderable as HP P/N 54600-68701)</b>
	5041-9482		Pouch
	54601-44101		Front-panel cover
	<b>Input Cable</b>		
	54620-61801	1	Cable, Woven (includes probe leads)
	5959-9333		Package replacement probe leads (quantity 5)
	5959-9334		Package replacement probe grounds (quantity 5)
	5959-9335		Package replacement pod grounds (quantity 5)
	5090-4356		Package replacement grabbers (quantity 20, includes 1 5959-9334)
	01650-94309		Package of probe labels

---

## Performance Characteristics

---

# Performance Characteristics

This chapter lists the operating characteristics and performance specifications for the HP 54620A/C Logic Analyzer.

Table 17

Input channels	
Number of Channels	16, numbered 0-15.
Channel input cable	HP 54620-61801 with channels grouped in two sets of 8. Instrument is compatible with 16-channel HP 1650-61607 cable and accessories.
Input R&C	~100 k $\Omega$ and 8 pF.
Maximum Input	$\pm$ 40 Volts peak.
Dynamic range	$\pm$ 10V about threshold.
Minimum input	500 mV peak-to-peak about threshold.
Minimum Input Voltage Overdrive	To meet timing accuracy, the threshold value must be within 20% of the 50% value of the input signal.
Threshold Setting	Threshold levels can be assigned to the input channels in groups of 8 channels (0-7 and 8-15) and external trigger.
Threshold Range	$\pm$ 6.0 Volts.
Threshold Accuracy <sup>1</sup>	$\pm$ (3% of setting $\pm$ 100 mV).
Preset threshold levels	TTL = 1.5 V. CMOS = 2.5 V. ECL = -1.3 V.
Channel-to-Channel Skew	2.0 ns typical. 3.0 ns maximum.

<sup>1</sup>Performance specification, tested by threshold test. See Chapter 5, "Testing, Adjusting, and Troubleshooting the Analyzer."

Table 18

---

**Horizontal System**

---

Sweep Speeds	1 s/div to 5 ns/div, Main and Delayed Sweep. When Auto Glitch Detect is disabled, in the Main display mode, you can set the sweep speed to 2 s/div and 5 s/div.
Accuracy	0.01% of reading; Main, Delayed sweeps, and verniers.
Horizontal Modes	Main, Main & Delayed, and post acquisition pan and zoom.
Cursor Accuracy	<p>Single channel <math>\pm</math> (Sample Period + 0.01% of reading) <math>\pm</math> 0.2% of screen width.</p> <p>Dual channel <math>\pm</math> (Sample Period + Ch. to Ch. skew + 0.01% of reading) <math>\pm</math> 0.2% of screen width.</p>
Delay Jitter	10 ppm.
Delay Range	<p>Pre-trigger (Negative time).</p> <p>Maximum delay is independent of time reference (left, center, right).</p> <p>For sample periods of 2 and 4 ns, and all sample periods with Auto Glitch Detect disabled, maximum pre-trigger delay is 8077 times the sample period.</p> <p>For sample periods greater than 4 ns, with Auto Glitch Detect enabled, the maximum pre-trigger delay is 2019 times the sample period.</p> <p>Post-trigger (from trigger point to start of sweep).</p> <p>From 5 ns/div to 1 <math>\mu</math>s/div (sample period 2 ns to 8 ns), and all sweep speeds with Auto Glitch Detect enabled, the delay range is 8.839 ms.</p> <p>From 2 <math>\mu</math>s/div to 1 s/div (sample period &gt; 8 ns), with Auto Glitch Detect enabled, delay range is 1,048,575 times sampling period, not to exceed 100 s.</p>
Delayed Sweep Operation	2X to 200 million X main sweep setting. Delayed can be as fast as 5 ns/div but must be at least 2X main sweep.
Post Acquisition Pan & Zoom Operation	Acquired waveforms may be panned across the display or expanded for enhanced viewing by simply changing time/div or delay settings.

Table 19

---

**Acquisition System**

---

Maximum Sample Rate	500 MSa/s.
Resolution	Single bit.
Simultaneous Channels	16.
Record Length	<p>2K Samples at sampling periods of 8 ns and slower ( sweep speeds of 1 <math>\mu</math>S/div to 1 S/div).</p> <p>8K samples at sampling periods of 2 ns and 4 ns (sweep speeds of 5 nS/div to 500 nS/div).</p> <p>When Auto Glitch Detect is disabled, its acquisition system has a record length of 8K samples at all sweep speeds. When Auto Glitch Detect is disabled, you can increase the sweep speed to 2 s/div and 5 s/div in the Main display mode.</p>
Minimum Update Rate	10 full screens per second independent of the number of channels being displayed (assumes no measurements).
Glitch Capture	Automatically activated at all sweep speeds where sampling period is slowed to be greater than 4 ns (1 $\mu$ S/div and slower) when Auto Glitch Detect is enabled. Will capture pulses as narrow as 3.5 ns at all activated sweep speeds. Maximum glitch width is sample period - 1 ns.



Table 20

---

**Trigger System**

---

General	Sources	All Channels & External.
	Auto/Normal Operation	Auto will produce a free-running display if the trigger is not found. Normal causes the analyzer to wait indefinitely for a trigger to start acquiring data.
	Modes	Edge, Pattern, and Advanced.
	Edge	A single edge can be specified on channels 0-15 and External. Edge may be rising, falling, or either.
	Pattern	Analyzer will trigger upon entering a pattern of high, low and don't care levels on all of the channels and external trigger input. A single edge (rising, falling or either) can be ANDed with this pattern; the edge then determines when the trigger will occur.
	Advanced	Two pattern and edge terms can be combined with operators to create a very specific trigger event.
	Advanced Operators	AND, OR, Then, Entered, Exited, Duration > time, Duration < time, and Occurs N times.
	Maximum Occurrence	$2^{20}-1$ .
	Edge Recovery Time	Sweep speeds of 5 nS/div to 1 $\mu$ S/div: 28 ns Sweep speeds of 2 $\mu$ S/div and slower: 20 ns + 1 sample period.
	Minimum Pattern Setup to Edge for Trigger	3 ns + channel-to-channel skew for all sample periods.
	Minimum Pattern Hold to Edge for Trigger	5 ns + channel-to-channel skew for all sample periods.
	Minimum Detectable Pattern Width	13 ns + channel-to-channel skew at sweep speeds of 5 nS/div to 1 $\mu$ S/div. At sweep speeds of 2 $\mu$ S/div and slower = (1 ns + 1 sample period + channel-to-channel skew + 0.01%).
	Minimum Settable Duration	At all sweep speeds = 2 sample periods or 16 ns, which ever is greater.

External trigger	Input R & C	~ 1 Meg $\Omega$ and 12 pF, compatible with HP 1007X probes.
	Maximum Input	$\pm 40$ V peak.
	Trigger Threshold	$\pm 6$ volts, settable in 50-mV increments.
	Threshold Accuracy <sup>1</sup>	$\pm 100$ mV or 6% of setting, whichever is greater.
	Minimum Input Change	200 mV pp.
	Minimum Pulse Width	20 ns.
Trigger Output	Output is a rising edge at the trigger point.	
	Output Level	0 to $\geq 2.0$ V into 50 $\Omega$ 0 to $\geq 4.8$ V open circuit.
	Delay, data in to trigger out	~ 85 ns.
	Jitter	$\pm$ Sample period + 10 ppm.
	Maximum Output Rate	$\cong 2$ kHz (HP 54620A), $\cong 1.5$ kHz (HP 54620C) with the analyzer stopped, 20/sec running.

<sup>1</sup> Performance specification, tested by threshold test. See Chapter 5, "Testing, Adjusting, and Troubleshooting the Analyzer."

Table 21

---

**Display System**

---

Display	7" Raster CRT (HP 54620A) 5.8" Active Matrix Color LCD Display (HP 54620C)
Resolution	256 Vertical by 500 Horizontal points.
Controls	Front-panel intensity control (HP 54620A).
Graticule	Selectable 8 X 10 grid frame, or none.
Storage Scope	Autostore saves previous sweeps in half-bright display and the most recent sweep full-bright display. This allows easy differentiation of current and historic information.

Table 22

---

**Measurement Functions**

---

Automatic Measurements	The analyzer will perform measurements on the selected input channel(s). These measurements are continuously updated.
Single Channel	Frequency, Period, +Width, -Width, and Duty Cycle.
Dual Channel	Channel-to-Channel delay, Hold time, and Setup time.
Cursor Measurements	Two cursors can be positioned on the display to make time measurements or read the value of the waveforms at the cursor. The cursors will track changes in time/div and delay controls. Readout in Time, 1/time, Hexadecimal, and Binary.

Table 23

---

**Setup Functions**

---

Autoscale	Selects all active channels and places them in the display. Channels not previously displayed will be added below those channels already being displayed with the lowest numbered channel at the top. Higher-numbered channels will be displayed in order down the display. Sweep speed is set to give an optimally scaled display of all the active channels. Triggering (except for auto/normal mode) and channel labels are not affected. Requires a signal with 49-Hz frequency. Undo Autoscale function returns the instrument to the setup prior to Autoscale being activated.
Save/Recall	16 front-panel setups can be stored and recalled from nonvolatile memory.
Trace Memory	Two volatile pixel memories allow storage of Autostore waveforms.
Channel Labels	Each channel may be identified with a six-character label. Labels can be created from a front-panel label generator and a library of up to 75 preset and user-defined labels.
Channel Color	Each channel may be assigned one to four waveform colors. Colors can be used to group related channels and/or distinguish unique channels.
Probe Calibrator	Amplitude 5.0 V, Frequency 9.8 kHz (HP 54620A). Amplitude 5.0 V, Frequency 8.3 kHz (HP 54620C).

Table 24

---

**Power Requirements**

---

Voltage selection	Automatic.
Line Voltage Range	90 to 250 Vac.
Line Frequency	48 to 445 Hz.
Maximum Power Consumption	220 VA.

Table 25

---

**General Characteristics for HP 54620A Only**

---

These general characteristics apply to the HP 54620A only.

Environmental Characteristics	Meets the requirements of MIL-T-28800E for Type III, Class 3, Style D equipment as described below.	
	Ambient Temperature	Operating: $-10^{\circ}\text{C}$ to $+55^{\circ}\text{C}$ . Non-operating: $-51^{\circ}\text{C}$ to $+71^{\circ}\text{C}$ .
	Humidity <sup>1</sup>	Operating: 95% RH at $40^{\circ}\text{C}$ for 24 h. Non-operating: 90% RH at $65^{\circ}\text{C}$ for 24 h.
	Altitude	Operating: To 4,570 m (15,000 ft). Non-operating: To 4,570 m (15,000 ft).
	Vibration	Operating 15 min along each of the three major axes; 0.025-in peak-to-peak displacement, 10 Hz to 55 Hz in 1-minute cycles. Held at 10 min at 55 Hz (4 g at 55 Hz).
	Shock	Operating 30 g, 1/2 sine, 11-ms duration. 3 shocks/axis along major axis. Total of 18 shocks.
EMI, Military	MIL-T-28800E	Meets the requirements in accordance with MIL-T-28800 paragraph 3.8.3 table IX, and MIL-STD-461C.
	CE01	Part 2.
	CE03	Part 2.
	CS01	Part 2.
	CS02	Part 2 (limited to 100 MHz).
	CS06	Part 5.
	RE01	Part 5 measured at 6 inches, 15 dB relaxation to 20 kHz; exceptioned from 19 kHz to 50 kHz.
	RE02	Part 2 (limited to 1GHz) full limits of class A1C and A1F with option 002 installed. Without option 002 installed, 10 dB relaxation from 10 kHz to 100 kHz.
	RS03	Part 2, limited to 3 V/meter from 14 kHz to 1 GHz (with option 001 installed); slight trace shift from 80 MHz to 200 MHz..

<sup>1</sup>Tested to Hewlett Packard environmental specification section 758 for class B-1 products.

Table 26

---

**General Characteristics for HP 54620A and HP 54620C**

---

These general characteristics apply to the HP 54620A and HP 54620C.

EMI, Commercial	This product meets the requirement of the European Communities (EC) EMC Directive 89/336/EEC.		
Emissions	EN55011/CISPR 11 (ISM, Group 1, Class A equipment).		
Immunity	EN50082-1	Codes <sup>1</sup>	Notes <sup>2</sup>
	IEC 801-2 (ESD) 4kV CD, 8kV AD	1	A
	IEC 801-3 (Rad.) 3V/m	1	A
	IEC 801-4 (EFT) 0.5kV, 1kV	1	B
<sup>1</sup> Performance Codes:			
1 PASS—Normal operation, no effect.			
2 PASS—Temporary degradation, self-recoverable.			
3 PASS—Temporary degradation, operator intervention required.			
4 FAIL—Not recoverable, component damage.			
<sup>2</sup> Notes:			
A TTL logic threshold with all cables disconnected.			
B TTL logic threshold with HP-IB cable connected.			
Physical	Size	Height 172.7 mm (6.8"), Width 322.6 mm (12.7"), Depth 317.5 mm (12.5").	
	Weight	6.8 Kg or 15 LB (HP 54620A), 5.1 Kg or 11.3 LB (HP 54620C).	
Safety	Self-certified to IEC 348/HD401, UL 1244, CSA-C22.2 No. 231 (Series M-89).		

Table 27

---

**General Characteristics for HP 54620C Only**

---

These general characteristics apply to the HP 54620C only.

Environmental Conditions	These instruments meet Hewlett-Packard's environmental specifications (section 750) for class B-1 products.
Temperature	Operating: 0°C to +55°C (+32°F to +131°F). Non-operating: -40°C to +70°C (-40°F to +158°F).
Humidity	Operating: up to 95% relative humidity (non-condensing) at +40°C (+104°F) for 24 h. Non-operating: up to 90% relative humidity at +65°C (+149°F) for 24 h.
Altitude	Operating: up to 3,048 meters (10,000 ft). Non-operating: up to 12,192 meters (40,000 ft).
Vibration	Operating: Random vibration 5-500 Hz, 10 minutes per axis, 0.3 grms. Non-operating: Random vibration 5-500 Hz, 10 minutes per axis, 2.41 grms; Resonant search, 5-500 Hz swept sine, 1 octave/minute sweep rate, 0.75g, 5-minute resonant dwell at 4 resonances per axis.

 Messages



---

# Messages

This chapter presents the various messages displayed by the instrument, explains what they mean, and gives instructions for corrective action if necessary.

---

## Messages

### Address Error

A processing fault occurred during operation. Cycle power to the analyzer, or perform a hard reset by cycling power with the two rightmost softkeys depressed. If this does not correct the problem, contact your HP Sales Office for assistance.

### Are you REALLY Sure?? Overwrite ALL 75 labels, YES to proceed

This message appears when you press Yes to confirm initialization of the label list.

- To initialize the label list, press the Yes softkey.
- To cancel initialization, press the No softkey.

### Autostore data on screen, press Erase to erase screen

This message appears when you try to turn off a trace memory while Autostore data is on the display. To clear the display, press Erase.

### Copying screen for printing ...

This message appears while the display is being buffered into spool memory before printing.

### Currently defined measurement already selected

This message appears when you press the Measure key for a measurement that is already defined and is being updated in the message line.

### Currently Selected channel is off - turn on to move

The channel you selected with the Select knob is off. These channels appear highlighted in the upper-left corner of the measurement display. Either turn on the channel before moving it, or select a different channel to move. To turn on the channel:

- 1** Select the channel using the Select knob.
- 2** Press On/Off.
- 3** Press the On softkey under the labeled channel on the softkey line.

To select a different channel to move, use the Select knob.

### **Delay at limit**

You have exceeded either the positive or negative time limit for the sweep delay. The limits depend on the current Time/Div setting, sampling rate, and whether the Horizontal Mode is Main or Delayed. See Chapter 4, “Ensuring Accurate Measurements,” for more information on interaction between time functions in the analyzer.

### **Delay at limit - use delayed sweep to view large negative time**

This message appears when you set the analyzer to a much faster sweep speed after a single acquisition, where the delay setting is large, but the delayed sweep window is off (main only). To see the desired part of the waveform, change the sweep speed to a slower setting, turn the delayed sweep on, or do both.

### **Delay =**

When the Horizontal Mode is Delayed, this message appears while you are adjusting the Delay knob, to inform you of the current delay time setting.

### **Duration time at limit**

This message appears when, in the Advanced Trigger menu, you try to adjust the duration setting for a pattern to a value less than the minimum or greater than the maximum. The minimum and maximum values are determined by the Time/Div and sampling interval, so you may be able to work around the problem by changing the Time/Div setting. See Chapter 4, “Ensuring Accurate Measurements,” for more information on the interaction between various analyzer time base functions.

### **Front panel locked**

This message appears when an instrument controller, such as a PC or workstation, has locked the analyzer’s front panel using the SYSTEM:LOCK command.

### **Illegal Instruction**

A processing fault occurred during operation. Cycle power to the analyzer, or perform a hard reset by cycling power with the two rightmost softkeys depressed. If this does not correct the problem, contact your HP Sales Office for assistance.

**Key not used**

This message appears when you press a softkey that is not valid for the current menu.

**Label List Re-Initialization Aborted**

This message appears when you press the No softkey during any step of label list reinitialization. Initialization of the label list is canceled, and the top-level label list menu reappears.

**Label List Re-Initialization is Complete!**

This message appears after the analyzer reinitializes the label list.

**Measurement already selected**

This message appears when you select a single-channel measurement that is already running. Note that measurement results for the selected measurement are displayed on the message line, but are temporarily overwritten by this message.

**Must cancel print first**

This message appears when you try to reconfigure the interface parameters for the I/O module while printing. You must either cancel printing with the Cancel Print softkey or wait until printing has completed before reconfiguring the interface.

**No active cursor**

This message appears when you turn the Entry knob while using a menu that has no field selectable via Entry. Normally, for those menus, the softkeys, Select, or Move are the only valid choices.

**No printer interface installed**

You selected Print Screen from the Print/Utility menu. However, there is no printer interface module installed. You must install an HP interface module (Centronics, HP-IB, or RS-232, as appropriate) for the analyzer to connect to the printer.

### No signal found

This message appears when you select Autoscale, but the analyzer was unable to find an input signal on any channel at any threshold setting.

- Check that the input cable is correctly connected to the analyzer.
- Check that the probes are connected to valid signal lines in the circuit under test.
- Check power to the circuit under test.
- Check the activity indicators.

### Not configured to print

You have the interface settings menu configured for “Connect to Computer.” If you have a printer connected to the interface (not a computer), you can set up the printer as follows:

- 1 Press Print/Utility.**
- 2 Press RS-232 Menu or HP-IB menu, depending on the interface installed.**
- 3 Press the Connect To softkey until one of the following is highlighted:**
  - HP Print if an HP printer is connected.
  - Epson if an Epson-compatible printer is connected.
  - HP Plot if an HP plotter or plotter compatible with HP-GL is connected. (Some HP printers with the HP-PCL V language will also work with this setting.)

### Occurrence count at limit

The count for occurrences of an edge in the Advanced Trigger menu must be set to a value between 1 and 1048575 inclusive.

### Operation Not allowed on Trigger In

This message appears when you move the Position knob while the Ext Trig input is the selected channel.

### Press STOP to increase print speed

This message appears when you are printing while the analyzer is acquiring data in Run mode. Because acquiring and displaying waveforms uses controller time that could otherwise be used for printing, you can speed printing by stopping acquisition.

**Print canceled**

This message appears when you press the Cancel Print softkey to stop printing.

**Printer not responding**

You selected Print Screen in the Print/Utility menu, and there is an interface installed, but the printer is not responding.

- Check that the printer is turned on and has paper.
- Check that the interface module for the HP 54620A/C is connected to the printer and that the correct interface type is being used.

**Printing done**

This message appears when the analyzer has finished copying the screen to the printer.

**Privilege Violation**

A processing fault occurred during operation. Cycle power to the analyzer, or perform a hard reset by cycling power with one of the softkeys depressed. If this does not correct the problem, contact your HP Sales Office.

**Re-Initializing the Label List . . . .**

This message appears briefly while the analyzer is re-initializing the label list.

**Screen and setup saved to memory**

This message appears when you save the current display and setup using the Trace memory menu.

**Selected channel at bottom of screen**

This message appears when you turn the Move knob counterclockwise and the selected channel is already at the bottom of the display.

### **Selected channel at top of screen**

This message appears when you turn the Move knob clockwise and the selected channel is already at the top of the display.

### **Setup recalled**

This message appears after the analyzer restores the configuration from the specified memory location.

### **Setup saved**

This message appears when you press the Save key in the Setup menu, indicating that the analyzer setup was saved to the selected memory location (1 through 16).

### **Test failed. err =**

This message appears if one of the analyzer self-tests fails. See chapter 5, “Testing, Adjusting, and Troubleshooting the Analyzer,” for more information on how to run self-test and what to do if self test fails.

### **Test passed**

This message appears when one of the analyzer self-tests passes.

### **This will overwrite ALL 75 current labels, YES to proceed**

This message appears when you select the Initialize Label List softkey in the Label menu.

- To proceed with initialization, press the Yes softkey.
- To cancel initialization, press the No softkey.

### **Threshold at limit**

The threshold setting is used by the analyzer input comparators to decide whether a signal is a logic high or logic low. The threshold must be set to a value between -6.00 V and +6.00 V inclusive.

### **Time/Div at limit**

The time per division must be set to a value between 1 s/div and 5 ns/div inclusive.

### **Trace memory cleared**

This message appears when you press the Clear Mem softkey for either Memory 1 or Memory 2 while in the Trace memory menu. It confirms that the selected memory was cleared.





---

## Glossary

**Acquisition** is the process by which the logic analyzer collects data. The analyzer acquires data by sampling the voltage on each input channel and comparing it to the threshold voltage to determine whether the input is high or low. In Normal trigger mode, the analyzer begins filling the pre-trigger buffer with data. When that buffer is full, the analyzer will begin searching for the trigger event. In Auto trigger mode, the analyzer fills the pre-trigger buffer, then searches for the trigger event for a predetermined interval.

**Acquisition memory** stores the acquired sample. This memory is part of the acquisition subsystem, and is located in the sample RAM.

**Acquisition memory depth** is 16 bits wide and 2048 samples deep at sweep speeds from 1 s/div to 1  $\mu$ s/div. When the sweep speed becomes faster than 1  $\mu$ s/div, the glitch detection circuitry is disabled, and acquisition memory is 16 bits wide and 8192 samples deep. Acquisition memory is located in the acquisition subsystem sample RAM.

**Advanced trigger** consists of two pattern and two edge sources combined with a variety of operators to form the complete Advanced trigger specification. Advanced trigger is

best used when the events you want to capture are defined by a complex series of waveform events in the system, and neither pattern mode nor edge mode are capable of clearly resolving the necessary sequence.

**Aliasing** is occurring whenever the waveform display changes more than expected, as you expand the time base. Aliasing is due to under sampling.

**Auto Glitch Detection** is enabled automatically when the analyzer is powered up. The glitch detection circuitry helps prevent aliasing by identifying additional transitions that occur between samples. Auto Glitch detection is disabled for time base settings where the sampling interval is 4 ns or faster. At these sweep speeds, the analyzer can reliably sample all signals that are within the bandwidth of its probing system, thus preventing aliases. See also Glitch mode.

**Auto trigger mode** causes the analyzer to fill the pre-trigger buffer, then searches for the trigger event for a predetermined interval. If no trigger is found, the analyzer forces a trigger and displays the data as though the trigger had occurred.

**Autoscale** performs a simple one-button setup of the analyzer,

including setting the time base and thresholds and displaying waveforms for channels connected to active signals.

**Autostore** records the result of every acquisition on the display in half-bright tone. When Autostore is on, the analyzer updates pixel (display) memory with new acquisitions, but does not erase the results of previous acquisitions.

**Channel controls** allow you to move or rearrange channels, turn them on or off, and add descriptive labels.

**Clock channel** is the reference point for the setup-time and hold-time measurements.

**Control knobs** include the Time/Div, Delay, Select, Position, Entry, and display intensity knob.

**Cursors** are used to measure either time between particular points on the display or numeric values of the currently displayed waveforms.

**Data acquisition** See “Acquisition.”

**Data channel** is the channel for which you want to measure setup or hold time.

**Delay time** in Main sweep is the time between the current trigger and the time reference point. In Delayed sweep, it is the time between the center of the delayed sweep window and the time reference position. In dual-channel measurements, it is the time between the transition on the start channel and a transition on the end channel.

**Delayed sweep** is the analyzer display function that magnifies the contents of sample memory. Use delayed sweep to zoom in on a portion of the waveform and examine it in greater detail.

**Display memory** is also called pixel memory. The display memory is part of the display subsystem, and is located in the waveform RAM. A data-to-waveform conversion gate array is provided to convert the data and display the acquisition. Also see “Autostore.”

**Dual-channel measurements** measure the time between edges on two different channels, including channel-to-channel delay, setup time, and hold time.

**Duration** is the time or signal width measured using advanced trigger. In an advanced trigger, you can set the minimum duration by pressing a softkey.

**Duration trigger operators** in advanced trigger, allow you to specify a duration on which the analyzer should trigger. Duration greater-than and less-than operators are available, and are valid when only pattern terms are involved, and are not selectable when any edge terms are selected as a source.

**Duty cycle** can be measured using single-channel measurements. The analyzer measures the period and positive width, and then calculates the duty cycle by dividing the period into the pulse width and multiplying the result by 100%.

**Edge trigger** is a single rising or falling edge (or either) that must be recognized on an input channel to satisfy the trigger condition.

**End channel** is the channel for which you want to measure delay time.

**Entered trigger operator** is used in the advanced trigger and in the regular pattern trigger. “Entered” means that the trigger

qualifier is satisfied as soon as the input waveforms have transitioned from a state that does not match the pattern to a state that does match the pattern.

**Erase** clears the current display and acquisition memory.

**Exited trigger operator** is used in the advanced trigger. The trigger qualifier is satisfied when the input waveforms transition out of a state that matches the pattern to a state that does not match the pattern.

**External trigger input** allows you to trigger the analyzer from another instrument or another signal in the circuit under test. The external trigger signal is available in edge, pattern, and advanced trigger to use as either an edge or pattern qualifier for the trigger condition.

**Frequency** can be measured using single-channel measurements. The analyzer selects the first and third transitions at the left side of the visible display, measures the period as the delta time between these two transitions, then calculates the frequency as the reciprocal of the period.

**Glitch mode** is indicated by “GL” on the status line. To prevent miss-

ing glitch pulses, the analyzer automatically enables glitch capture once the time/div setting is 1  $\mu\text{s}/\text{div}$  or slower. In glitch capture mode, the analyzer uses memory resources to record an event where at least two transitions occurred between sample periods. The analyzer can capture pulses as narrow as 3.5 ns and as long as the sample period -1 ns at any sweep speed.

**Graticule** refers to the hash marks on the display. These marks can be set to full, frame, or turned off.

**Hold time** is the time for which a data input to a clocked device must remain stable after the active edge of the clock occurs. Violating the hold-time specification of a device can lead to unstable circuit operation.

**Horizontal controls** adjust the time base, horizontal mode, and delayed sweep functions.

**Labels** are terms defined or chosen from a predefined list to associate input channels with their functions in the system under test. When you assign a label ending in a digit, such as D0, the analyzer inserts the label into the nonvolatile label list, automatically increments the digit, displays the modified label in the entry field, and selects the

next channel. The label generator also allows you to assign colors to channels.

**Measurement algorithms** are used to calculate input frequency, input period, duty cycle, positive width, and negative width.

**Measurement field** is located below the memory bar. This area is used to display results for single- and dual-channel measurements, activity indicators, trigger settings, error messages, and status messages.

**Memory** See “Display memory,” “Setup memory,” or “Trace memory.”

**Memory bar** is the horizontal line below the waveform display area which shows the amount of acquisition memory that is displayed, and the position of the display with respect to acquisition memory. When the analyzer is stopped, you can change the size of the display with respect to acquisition memory using the Time/Div control knob, which allows you to zoom in on a specific portion of memory. You can also use delayed sweep or pan the display using the Delay knob.

**Minimum detectable pattern width** is the minimum time for which an input pattern must remain stable for

the analyzer to recognize it as matching a pattern trigger specification. At very fast sweep speeds (small Time/Div settings), the pattern width is nearly a constant value. At time base settings of 2  $\mu\text{s}/\text{div}$  and slower, this is approximately a constant value plus one sample period.

**Minimum duration trigger setting**

specifies the shortest duration setting that the analyzer can accurately verify against the incoming pattern. The minimum duration trigger setting is two sample periods or 16 ns, whichever is greater.

**Negative width** is the time for which a signal is low.

**Normal trigger mode** causes the analyzer to begin filling the pre-trigger buffer with data. When the buffer is full, the analyzer will begin searching for the trigger event. When the trigger event is found, the analyzer fills the post-trigger buffer and displays the acquisition memory. Until the analyzer finds the trigger, the acquisition will not be displayed, and the analyzer will search for the trigger indefinitely.

**Occurrence trigger operator** is used to specify the number of times an edge term or a pattern and edge term combination occurs. Occur-

rence operators are available in advanced trigger mode, are valid only when at least one edge term is involved, and are not selectable when only pattern terms are selected as a source.

**Palettes** include colors that you can assign to channels with the HP 54620C color logic analyzer. Six color palettes are available, and are individually named so that you can select the palette that best suits your needs. In each palette, colors are used for cursors, waveforms, soft-keys, and Autostore. A monochrome palette is also available.

**Pan the display** means the acquisition moves horizontally on screen when you rotate the Delay knob. Panning the display adjusts the amount of time between the trigger event and the time reference point on the display.

**Pattern trigger** defines a set of pattern of highs, lows, and don't care inputs that must be recognized across the input channels during any given input sample. The pattern may be combined with one edge on any input channel to form the complete trigger specification. The pattern trigger occurs when the pattern is entered.

**Period** is calculated by selecting the first and third transitions from the left side of the visible display and measuring the delta time between these two transitions.

**Positive width** is the time of a signal or glitch that is high.

**Pixel memory** See “Display memory.”

**Print** copies the current display to the attached printer. You must have either an HP-IB, RS-232, or Centronics/parallel Interface module to use the print capability.

**RUN indicator** is displayed at the right end of the status line when the acquisition is running.

**Sample period** is the interval at which the input is sampled. The analyzer acquires data by sampling the voltage on each input channel and comparing it to the threshold voltage to determine whether the input was a logic high or logic low. The acquisition mode, trigger functions, delayed sweep, and measurement functions depend on the sample period. The sample period, in turn, depends on the Time/Div setting.

**Setup memory** allows you to save the current configuration of the in-

strument, including time base, threshold, channel settings, measurement definitions, and labels. You can use these later to verify the results of a change, or you can use them regularly for testing and troubleshooting. These memories are non-volatile.

**Setup time** is the time for which a data input to a clocked device must remain stable before the active edge of the clock occurs. Violating the setup time specification of a device can lead to unstable circuit operation.

**Signal inputs** connect the logic analyzer acquisition system to the probes.

**Single indicator** is shown as the letters “Sngl” in the display and indicates that the current display was captured by pressing the Single key (a single acquisition was performed, then the analyzer stopped).

**Single-channel measurements** measure time between sets of events on the same channel, then calculate the appropriate values based on the definition of the measurement. Measurements include period, frequency, duty cycle, positive width, and negative width.

**Softkeys** set up various options for major functions. The softkeys change depending on the function you select. Some softkeys have an immediate action, and others allow you to scroll through a list of choices. Some softkeys are labeled with two choices below; the highlighted choice is currently active. When several softkeys are displayed with a labeled bar over them, they are either related, or the choices are mutually exclusive.

**Start channel** is the reference point for a delay measurement.

**Status indicators** are at the top line of the display and show channels turned off, the sampling interval, glitch mode, delay, time base setting, trigger condition, and acquisition mode.

**STOP indicator** is displayed at the right end of the status line when the acquisition has been stopped.

**Storage keys** control start and stop of acquisition, persistent acquisition, and screen erasure.

**STORE indicator** is displayed at the right end of the status line when Autostore is selected.

**Sweep speed (time base)** is the amount of time per division on the display, and is shown on the status line. When you vary the Time/Div setting while running an acquisition, the sample period is also being adjusted.

**Thresholds** define the voltage at which there is a change from low to high. Thresholds specified can be TTL, CMOS, or ECL, or user-defined.

**Time base** See “Sweep speed.”

**Trace memory** is also called pixel memory. Trace memories allow you to save the visible portion of the acquisition (the displayed waveform) for later recall and comparison with other measurements. Trace memory is normally volatile. However, adding an interface module makes the trace memory nonvolatile. Trace memory also saves the current configuration, separate from the 16 setup memories.

**Trigger** is the point that causes the analyzer to begin storing acquisition data. The trigger can be a signal edge, a pattern, or a combination of edges, patterns, occurrences, and durations. See “Edge trigger,” “Pattern trigger,” or “Advanced trigger.”



**Trigger mode** can be set to Normal or Auto. See “Normal trigger mode” or “Auto trigger mode.”

**Trigger output** is an output signal used to trigger an external measurement system or other device. This output is pulsed when the analyzer’s trigger condition is satisfied and the analyzer begins acquiring data.

**Trigger output rate** refers to the rate at which the analyzer can generate the trigger output signal. It does this as fast as it can acquire data and update the waveform display, which is normally fast enough to trigger digital oscilloscopes. When triggering analog oscilloscopes, to obtain a faster trigger, stop the logic analyzer acquisition. The analyzer will continue to drive the trigger output, but will not have the overhead of data capture display updates. The trigger output is generated at a much higher rate, and the trigger is still valid.

**Vernier** is a softkey in the Main/Delayed menu that gives finer increments of the sweep speed.

**Waveform parameters** are measured using cursors, single-channel measurements, or dual-channel measurements.

**Width** refers to positive and negative duration of a signal. The signal width can be measured using single-channel measurements. In doing so, the analyzer measures the time between the first set of transitions at the left side of the visible display that begin and end the logic high or low value. See also “Minimum detectable pattern width.”

---

# Index

---

## A

- accessories
  - build for testing, 155
  - optional, 24–26
  - supplied, 22–23
- accumulating results, 58
- accuracy
  - concepts of measurement functions, 137
  - testing thresholds, 169
  - testing time intervals, 173
- acquisition
  - and channels that are off, 49
  - and trigger, 65
  - and trigger mode, 70–71
  - buffer, 46
  - concepts of glitch detection, 143–148
  - indicator for, 39
  - overhead affects trigger output rate, 107
  - process of, 55
  - setting up with Autoscale, 44–45
  - single, 56
  - starting, 46
  - stop to increase trigger out rate, 107, 110
  - stopping, 46
  - time reference example, 134
- acquisition behavior
  - repetitive run, 131
  - single shot, 131
- acquisition concepts, 129–138
- acquisition memory, 129–138
  - amount displayed, 41
  - and trigger event, 70
  - displayed by memory bar, 132
  - location of trigger event, 83–85
  - setting time reference in, 83–85
  - size relative to sweep speeds, 130
  - time reference concepts, 133
  - timebase affects time to fill, 138
  - trigger event position, 130
- acquisition results
  - save in trace memory, 113
- acquisition system
  - performance characteristics, 199
  - self-tests, 154
  - test, 151
- action keys, 37
- action to cause trigger, 71, 132
- activity check during Autoscale, 45
- activity indicators
  - for threshold test, 172
- adjusting
  - delay, 93
  - display brightness, 29
  - handle, 28
  - sweep, 93
- adjusting the analyzer, 150, 159
  - display, 162–163
  - display pattern, 163
  - vertical hold, 162–163
  - voltage tolerance, 160–161
- adjustments
  - display, 162–163
  - high frequency, 159
  - low frequency, 159
  - power supply, 160–161
- Adv, 69, 74–79
- advanced trigger, 65, 74–79
  - applications of, 67
  - overview display, 69
  - satisfying events to trigger analyzer, 79
  - setting up, 76
  - setup rules, 76
  - solve data acquisition problems, 76
- aliasing, 144
  - produces misleading information, 56
- Alternate color palettes, 30
- analyzer
  - acquisition memory concepts, 130
  - adjusting for performance, 159
  - built-in tests, 151
  - calculates delay time, 99
  - calculates duty cycle, 97
  - calculates hold time, 102
  - calculates input frequency, 96
  - calculates input period, 97
  - calculates setup time, 100
  - calculates widths, 97
  - checking LVPS, 165–168
  - circuit probing concepts, 139–142
  - concepts for making measurements, 128
  - concepts of glitch detection, 143–148
  - configuration preset, 119
  - connect to test threshold accuracy, 171
  - connect to test time interval, 174
  - delayed sweep concepts, 133
  - disassembling, 181
  - displaying glitch, 146
  - does not display ringing, 141
  - enables glitch capture, 143–148
  - fan running?, 167
  - See logic analyzer
  - measurement function concepts, 137
  - measurement process, 92
  - messages, 208
  - performance characteristics, 196
  - preset configuration, 119
  - relationships with timebase, 129–138
  - removing cover to adjust, 160–161
  - removing covers to service, 164
  - removing power supply, 187
  - removing system board, 186
  - removing the cabinet, 182
  - removing the display, 185
  - removing the fan, 183
  - removing the front panel, 184
  - removing the handle, 189
  - removing the keyboard, 188
  - replaceable parts, 180
  - resetting, 123
  - saves current trace waveform, 114
  - saves instrument setup, 114
  - setup to test time interval accuracy, 176
  - stores setup, 117
  - sweep speed and sampling intervals, 130
  - test accessories, 155
  - test channel thresholds, 172
  - testing and troubleshooting, 150
  - time reference concepts, 133
  - timebase concepts, 137
  - trigger function concepts, 132
  - trigger mode concepts, 131
  - triggers when events satisfied, 79
  - troubleshooting, 164–167
  - view of parts, 192
  - warm up before adjusting, 159
- analyzer controls, 35–36
- applications of cursor settings, 95
- applications of trigger
  - to complex situations, 67
  - to edges, 65
  - to patterns, 66
- apply squarewave signal to external trigger input, 109
- assemblies

- 
- ordering, 191–194
  - removing and replacing, 181
  - replacing on exchange program, 190
  - assigning colors to channels, 33
  - assigning labels, 60–63
  - associating channels and circuit signals, 40
  - associating circuit signals and input channels, 59
  - Auto Glitch Detect, 55
    - acquisition system specs, 199
    - disable to increase sweep speed, 48
    - disabling, 57
    - enabled by Autoscale, 45
    - enabling, 57
    - horizontal system specs, 198
  - Auto trigger mode, 70–71, 131
  - auto-increment
    - in labels, 63
  - Autoscale, 44–45
    - operation of, 45
    - performance characteristics, 203
    - try to display channels, 125
    - try to display trace, 123–124
    - undo, 44–45, 113, 119
  - Autostore, 58
    - and Erase, 58
    - and Single, 56
    - message, 209
  - Autostore data
    - cannot be measured, 92
- B**
- Benchlink for Microsoft Windows, 24–26
  - Berg strip, 156–157
  - best probing practices, 142
  - bezel
    - flexing on front panel, 188
  - binary readout, 94–95
  - blown fuse, 168
  - BNC
    - cable assembly, 171, 174
    - connector, 156–157
  - BNC connector, 157
  - board
    - training, 24–26
  - boards
    - power supply, 161
    - replaceable parts, 180
    - training, 25
  - brightness, 58
    - adjusting, 162–163
    - adjusting display, 29
    - control, 37
  - buffers
    - post-trigger, 70, 130–131
    - pre-trigger, 70, 130
    - pre-trigger overflow, 131
  - building test accessories, 155
  - built-in tests, 151
- C**
- cabinet
    - removing, 182
    - removing the handle, 189
  - cable
    - removing probe leads, 43
  - cables
    - calibration, to display, 185
    - calibration, to system board, 186
    - part number for, 22–23
    - probe, 42–43
    - ribbon, to display, 185
    - ribbon, to power supply, 187
    - ribbon, to system board, 184, 186
  - calculate
    - delay time, 99
    - duty cycle, 97
    - input frequency, 96
    - input period, 97
    - measurement values, 91
    - widths, 97
  - calibration
    - adjustments, 159
  - calibration cable
    - disconnect to remove display, 185
    - disconnect to remove system board, 186
    - take care when removing keyboard, 188
  - cancel printing, 88
  - capacitance of impedance, 139–142
  - capturing a glitch
    - concepts, 143–148
    - reconstructed waveform, 144
  - capturing single-shot events, 56
  - carrying case, 24–26
  - center
    - time reference displayed, 84
    - time reference position, 83–85
  - changing channel order, 50
  - changing time reference, 83–85
  - channel measurements, 98
    - dual, 92
    - single, 91, 96–97
  - channel problems, 125
  - channel-to-channel delay, 98–99
  - channels
    - assigning colors, 33
    - assigning labels to, 60–63
    - attach ground leads, 142
    - clock, 100, 102
    - connecting to test, 171, 174
    - data, 100, 102
    - enabled/disabled by Autoscale, 45
    - end, 92, 98–99
    - labels, 38, 40
    - list of those off, 39
    - message, 209, 213
    - naming, 40
    - numbers, 38, 40
    - order of, 50
    - performance characteristics, 197
    - positioning, 37, 50
    - preset configuration, 119
    - selecting, 37, 50
    - selecting for edge trigger, 47, 72
    - selecting for pattern trigger, 73
    - setting input threshold voltage, 53
    - start, 92, 98–99
    - test thresholds, 172
    - testing acquisition system, 154
    - testing threshold accuracy, 169
    - turning labels on or off, 59
    - turning on and off, 49
  - characteristics
    - See performance characteristics
    - probe input impedance, 139–142
  - checking
    - optional accessories, 24–26
    - package contents, 22–23
  - checklist
    - for solving problems, 123–125
-

- 
- circuit ground
    - connecting to analyzer, 42–43
  - circuit signals
    - associating with channel, 40
    - associating with input channels, 59
  - circuit under test
    - action to cause trigger, 71, 132
    - concepts of probing, 139–142
  - circuitry
    - glitch capture, 143–148
  - clear
    - cursors, 91, 94–95
    - measurement, 97
    - measurement field, 91
    - previously saved trace, 116
    - trace memory, 112
  - clearing labels, 64
  - clock channel, 100, 102
    - in hold time measurement, 103
    - in setup time measurement, 101
    - threshold accuracy, 169
  - clock edge
    - select for delay measurements, 98
  - CMOS threshold, 53–54
  - color of keys and relationship to function, 37
  - color palettes, 30, 41
    - channel colors, 40
    - colors in waveform display, 40
    - selecting, 31–32
  - colors
    - assigning to channels, 33
    - selecting palettes, 31–32
  - comparators
    - input, 54
  - comparing measurement results, 111
  - components
    - See replaceable parts
  - concepts
    - aliasing and glitch capture, 144
    - choosing timebase to capture glitch, 145
    - delayed sweep, 133
    - glitch detection, 143–148
    - input impedance, 139–142
    - making accurate measurements, 128
    - memory bar, 132
    - probe grounding, 140
    - probing circuit under test, 139–142
    - probing practices, 142
    - storage of samples, 130
    - time reference, 133
    - timebase and acquisition, 129–138
    - trigger functions, 132
    - trigger modes, 131
  - configuration
    - default, 44–45
    - preset default settings, 119
    - recalling, 118
    - saved in memory, 117
    - saving and recalling, 111–112
    - using Autoscale, 44–45
  - connecting
    - grabbers, 42–43
    - power cord, 27
    - to circuit ground, 42–43
    - to function generator, 171, 174
    - to pulse generator, 174
  - connecting to circuit ground, 42
  - connections
    - external trigger from scope, 106
    - external trigger using scope probe, 106
    - for trigger oscilloscope, 107
  - contents of analyzer package, 22–23
  - controls
    - front panel, 35–36
    - knobs, 37
  - covers
    - remove for service, 164
  - creating labels, 62–63
  - CRT, hazardous voltages, 181
  - cursors
    - activated by analyzer, 97
    - clearing, 91, 94–95
    - message, 211
    - moving simultaneously, 94–95
    - preset configuration, 119
    - readouts, 91, 94–95
    - use on irregular patterns, 97
    - use to measure waveform data, 89
    - use to test time interval accuracy, 176
    - used to measure period, 91
  - custom labels, 60–63
- D**
- damage to analyzer
    - power down before servicing, 164
  - damaged shipment, 22–26
  - data
    - measuring, 89
  - data acquisition
    - See acquisition
  - data captured
    - acquired by sampling, 129–138
    - examine with delayed sweep, 80
    - in time interval accuracy test, 177
    - to fill main display, 86
  - data channel, 100, 102
    - in hold time measurement, 103
    - in setup time measurement, 101
    - threshold accuracy, 169
  - data entry field, 37
  - Default color palette, 30
  - default configuration, 44–45
  - default setup, 113, 119
  - defective assemblies, 190
  - defining edge trigger, 74
  - defining labels, 62–63
  - defining sources, 74
  - delay, 39
    - adjusting, 93
    - and trigger event position, 70–71
    - channel-to-channel, 98–99
    - introduced by timebase, 138
    - measured on dual channels, 92
    - message, 210
    - setting, 37
  - delay indicator
    - for trigger position, 84
  - Delay knob, 37
    - used to pan display, 86
  - delay setting concepts, 133
  - delay time defined, 98
  - delay value displayed, 84
  - delayed sweep
    - changing main sweep Time/div, 82
    - concepts, 133
    - magnifies contents of sample memory, 80
    - setting up display, 82
    - shows glitch, 146
    - Time/div setting for, 82
-

- 
- delayed sweep window
    - edges used for measurement, 93
    - indicator for, 81
    - Time/div setting for, 81
  - delayed window
    - limited to data in main display, 86
  - delta t indicators, 95
  - design of probe tip, 140
  - design test ports, 142
  - device specifications
    - measuring hold time, 102–103
    - measuring setup time, 100–101
  - difference between trigger mode and trigger type, 71
  - digital multimeter
    - See multimeter
  - disassembly, 181
  - display, 38
    - adjusting brightness of, 29
    - adjusting pattern, 163
    - adjustment, 162–163
    - and Autostore, 58
    - and labels, 59
    - and trigger, 70, 131
    - erasing, 58
    - glitches, 143–148
    - main and delayed sweep displays, 82
    - of acquired data, 46
    - of waveform, 55
    - overhead affects trigger output rate, 107
    - removing, 185
    - replacing assembly, 166
    - self-test, 162–163
    - setting up delayed sweep, 82
    - to adjust, 163
    - turning labels on or off, 59–61
    - waveform, 40
  - display flashing, 39
  - Display softkey
    - in self-test menus, 162
  - display system
    - performance characteristics, 202
  - divider probe
    - used to reduce signal swing, 109
  - divider probe application
    - large-scale signal to ext. trigger input, 109
  - divisions on graticule, 87
  - dual-channel measurements, 98–99
    - channel-to-channel delay, 92
    - hold time, 92
    - setup time, 92
    - where displayed, 41
  - dummy load, 155
    - making, 158
  - duplicate labels, 63
  - duration
    - and advanced trigger, 67
    - message, 210
  - duration operators
    - for advanced trigger, 76
  - duration trigger, 74–79
    - affected by timebase, 129–138
  - dust cover, 24–26
  - duty cycle
    - calculated, 97
    - measurement, 91
- E**
- ECL threshold, 53–54
  - Edge, 47, 72
  - edge and pattern triggers combined, 76
  - edge qualifier in pattern trigger, 73
  - edge trigger, 47, 65, 72
    - applications of, 65
    - qualifying a pattern, 66
    - using external trigger input, 109
  - edges
    - defining for trigger, 74
    - of waveform disjointed, 146
    - set in channel measurements, 98
    - used to satisfy measurement criteria, 93
  - EMI performance characteristics, 204–206
  - end channel, 98–99
    - and edge, 92
  - entered (pattern trigger), 66
  - Entry knob, 37, 73
    - choosing edge trigger channel, 47, 72
    - choosing labels from list, 60–61
  - environmental characteristics, 204–206
  - equation
    - for voltage behavior, 141
- E**
- equipment
    - for servicing analyzer, 164
    - for testing time interval accuracy, 173
    - set up to test threshold accuracy, 170
  - Erase, 58
    - labels, 64
    - measurement field, 91
    - trace memory, 112
  - error messages, 208
    - where displayed, 41
  - errors in operation
    - See solving problems
  - events
    - and pattern trigger, 66
    - capturing single-shot, 86
  - examine captured data using delayed sweep, 80
  - exchange program, 190
  - exploded view, 192
  - extending trigger capabilities, 104
  - external trigger
    - connections, 106
    - signal margin, 109
  - external trigger input, 104
    - BNC, 108–109
    - logic threshold setting, 106
    - testing threshold accuracy, 169
    - used as edge trigger, 109
  - external trigger signal
    - available in all trigger types, 104
- F**
- factory-default settings, 44–45
  - failing self-tests
    - acquisition system, 154
    - keyboard, 153–154
    - ROM and RAM, 152
  - fan
    - disconnecting cable, 167
    - remove to remove power supply, 187
    - removing, 183
  - flashing
    - of indicators on display, 39
  - forced trigger, 70, 131
  - frequency measurement, 91
    - using delayed sweep window, 93
-

- 
- front panel
    - dust cover, 24–26
    - flex bezel to remove keyboard, 188
    - functions, 35–36
    - hooks, 184
    - message, 210
    - removing, 184
    - retainer tabs, 184
  - full-bright display, 58
  - function generator, 170
    - connect to for test, 171
    - for testing time interval accuracy, 173
    - set DC offset voltage, 172
    - setting up, 175
  - functional controls, 35–36
  - functions
    - on softkeys, 41
  - fuse, 168
  - G**
  - general performance characteristics, 204–206
  - glitch
    - as part of waveform, 92
    - capture and aliasing, 144
    - categories of, 143–148
    - detection, 143–148
    - shown in delayed sweep, 146
  - glitch capture
    - performance characteristics, 199
  - glitch detection circuitry, 130
  - glitch mode, 39, 48
  - good uses for advanced trigger, 67
  - good uses for edge trigger, 65
  - good uses for pattern trigger, 66
  - grabbers
    - connecting to circuit ground, 42
    - connecting to ground lead, 42–43
    - connecting to probe lead, 42–43
    - part number for, 22–23
  - graticule, 40
    - modifying settings, 87
    - preset configuration, 119
    - settings for hash marks, 81, 87
  - grid, 40
    - softkeys, 87
  - ground
    - probes for making measurements, 142
    - ground bounce, 141
    - ground inductance, 141
    - ground lead
      - connecting to probe cable, 42–43
      - part number for, 22–23
  - H**
  - half-bright
    - contrast, 163
    - display, 58
  - handle
    - adjusting, 28
    - removing from cabinet, 189
  - hash marks
    - in waveform display, 81, 87
  - hazardous voltages, 181
  - hex readout, 94–95
  - high-frequency probe circuit, 140
  - high-speed timing measurements
    - use probe ground, 142
  - hold time, 102–103
  - hold time measurement, 103
  - hooks on front panel, 184
  - hookups
    - for external trigger, 106
    - for triggering oscilloscope, 107
  - horizontal
    - hold, 163
    - mode, 39, 198
  - horizontal system
    - performance characteristics, 198
  - HP service
    - component info packets, 180
    - exchanging assemblies, 190
    - mail order system, 191–194
    - obtain to replace parts, 152–154
    - obtain to solve problems, 123
    - order dummy load, 158
    - policy for replacing assemblies, 164
  - HP-IB Interface module, 111
  - I**
  - immediate-action keys, 41
  - impedance of probes, 139–142
  - incorrect trace display, 124
  - increase
    - repetition of trigger output, 107
    - sweep speed, 145
    - trigger output rate, 110
  - indicators, 39
    - flashing, 39
    - for cursor settings, 95
    - measurement, 38
    - status, 38–39
    - STORE, 58
  - initializing label list, 64
  - input channels
    - performance characteristics, 197
  - input comparators, 54
  - input for external trigger, 108
  - input frequency calculated, 96
  - input period calculated, 97
  - input signals
    - setting threshold for, 53–54
  - input swing
    - minimum for analyzer, 109
  - intensity control
    - adjusting, 162–163
  - interface module
    - what to do if troubleshooting, 165–167
  - interface modules
    - documentation for installing and configuring, 88
    - make trace memory non-volatile, 111
    - used for printing, 81
  - interface parameters, 88
  - interfaces
    - message, 211
  - interval
    - of auto trigger, 70, 131
  - interval for sampling
    - concepts, 129–138
  - Inverse color palettes, 30
  - irregular patterns
    - use cursors to measure, 97
  - K**
  - keyboard
    - See keypad
    - removing, 188
    - self-test, 153–154
    - test, 151
  - keypad, 37
-

- 
- keys
    - action, 37
    - function of, 37
    - menu, 37
    - softkeys, 37
  - kit
    - rackmount, 24–26
    - training, 24–26
  - knobs
    - function of, 37
  - L**
  - Label, 59–64
  - label key
    - used in resetting analyzer, 123
  - label list
    - don't initialize during reset, 123
  - labeling inputs, 59
  - labels
    - and waveform display, 59
    - assigning, 60–63
    - auto-increment feature, 63
    - channel, 38, 40
    - defining, 62–63
    - duplicates, 63
    - initializing, 64
    - list management, 63
    - message, 209, 211
    - preset configuration, 119
    - settings stored with setup, 117
    - softkey, 38
    - turning on or off, 59
  - Left
    - time reference position, 83–85
  - limitations
    - only one edge in pattern trigger, 73
  - line switch, 27
  - line voltage
    - auto-adjusting for, 27
  - list
    - of channels that are off, 39
    - of disabled channels, 49
    - of optional accessories, 24–26
    - of replaceable parts, 193
    - of supplied accessories, 22–23
  - list of optional accessories, 25
  - logic analyzer
    - accessories supplied with, 22–23
    - See analyzer
    - Benchlink for Microsoft Windows, 24–26
    - carrying case for, 24–26
    - configuring with Autoscale, 44–45
    - features of, 52
    - functional controls, 35–36
    - keypad, 37
    - optional accessories, 24–26
    - preparing for use, 21
    - process of using, 18, 20
    - setup, 21
    - starting acquisition, 46
    - stopping acquisition, 46
    - turning on power to, 27
  - Logic levels, 54, 73
    - key use to test thresholds, 172
    - use to test time interval accuracy, 176
  - logic threshold, 53–55
  - logical operators
    - and advanced trigger, 74–79
  - low-frequency probe circuit, 139–142
  - LVPS
    - checking voltages, 165–168
    - ribbon cable, 166
    - thermal cut-out circuit, 167
  - M**
  - magnetic shielding, 24–26
  - magnification
    - of delayed sweep, 133
  - magnify content of sample memory, 80
  - mail order system
    - use to replace parts, 191–194
  - main sweep
    - Time/div for window, 81
    - Time/div setting for, 82
  - main timebase concepts, 133
  - maintenance, 164
  - making
    - dummy load, 158
    - test connectors, 156–157
  - making adjustments
    - for analyzer performance, 159
  - manuals
    - supplied, 22–23
  - margin on external trigger, 109
  - markers
    - for delayed sweep window, 81
    - for trigger position, 84
  - material list, 22–23
  - materials
    - for making test connectors, 156–157
    - list, 23
  - measurement
    - algorithms, 96
    - features, 52
  - measurement cycle
    - See measurement process
  - measurement field, 38, 41, 92
    - shows frequency or period, 94–95
    - shows maximum of 3 measurements, 96
  - measurement functions
    - concepts, 137
    - depend on sample period, 129–138
    - performance characteristics, 202
  - measurement process, 18, 20, 92
    - analyzer setup, 21
  - measurements
    - affected by trigger functions, 132
    - and channels that are off, 49
    - channel delay, 98
    - channel-to-channel delay, 92
    - concepts for making accurate, 128
    - dual-channel, 92
    - duty cycle, 96–97
    - frequency, 96–97
    - hold time, 92
    - manual using cursors, 89
    - period, 96–97
    - power supply voltages, 161
    - preset configuration, 119
    - setup time, 92
    - single-channel, 91, 96–97
    - width, 96–97
  - measuring
    - fan voltage, 167
    - frequency or period using cursors, 94–95
    - hold time, 102–103
    - LVPS voltages, 168
    - period using cursors, 91
    - setup time, 100–101
    - signals on system board, 166
    - voltages on power supply, 166
    - waveform parameters, 96–97
-

- 
- measuring waveform data
    - time between edges, 92
    - using cursors, 89
    - using dual-channel, 92
    - using single-channel, 91
  - memory
    - acquisition, 130
    - glitch detection, 130
    - preset configuration, 119
    - recalling setup from, 118
    - recalling trace waveform from, 115
    - setup, 113
    - trace, 112
    - used to capture glitch, 143–148
    - used to store setup, 117
  - memory bar, 41, 132
  - menu keys, 37
  - message line
    - shows measurement results, 100
    - shows measurements, 96, 99, 102
  - messages, 208
    - display area, 38
    - where displayed, 41
  - microprocessor system
    - events leading to failure, 78
    - setting up trigger, 78
  - Microsoft Windows
    - Benchlink software to interface logic analyzer, 24–26
  - minimum detectable pattern width
    - concepts, 132
  - minimum duration trigger
    - concepts, 132
  - minimum input swing, 109
  - missing trigger, 71, 131
  - mode, 70–71
    - glitch, 39, 48
    - trigger, 39, 70–71
  - modify graticule, 87
  - Monochrome palette, 30
  - moving channels, 50
  - moving cursors simultaneously, 94–95
  - multimeter
    - use to adjust display, 162–163
    - use to adjust power supply, 160–161
    - use to check LVPS, 168
    - use to monitor function generator, 170
    - use to troubleshoot analyzer, 164
  - N**
  - names
    - assigning to channels, 60–61
    - defining, 62–63
  - naming
    - channels, 40
    - input signals, 59
  - negative width measurement, 91
  - new labels, 62–63
  - no trigger, 71, 131
  - non-volatile settings
    - labels list, 63
  - non-volatile setup memory, 112
  - Normal trigger mode, 70–71, 131
  - numbering
    - of channels, 40
  - O**
  - occurrence
    - and advanced trigger, 67
    - count increments on edge & pattern, 78
    - message, 212
    - operators for advanced trigger, 76
    - trigger, 74–79
  - On/Off
    - "Off" channels, 49
    - use of measurements and channels that are off, 49
  - operating performance
    - adjusting, 159
  - operation of Autoscale, 45
  - operators
    - for trigger, 74–79
  - order of channels, 50
  - ordering new assemblies, 190–194
  - oscillator
    - verifying operation of, 173
  - oscilloscope probe
    - routes signal to external trigger input, 105
  - overview
    - display in advanced trigger, 74–79
    - of advanced trigger, 69
  - P**
  - palettes
    - selecting colors, 31–32
  - pan the waveform, 80, 86
    - concepts of delayed sweep, 133
    - concepts of memory bar, 132
  - parameters
    - for trigger operator, 74–79
    - measured using single channel, 96–97
  - parameters for interface, 88
  - part numbers
    - cable, 22–23
    - grabbers, 22–23
    - ground lead, 22–23
  - parts
    - for dummy load, 158
    - for test connectors, 156–157
    - removing and ordering, 180
  - parts list for analyzer, 193
  - passive probe impedance, 139–142
  - Pattern, 73
    - irregular, repeating, 94–95
  - pattern duration trigger
    - and sample period, 48
  - pattern trigger, 65, 73
    - adding edge qualifier, 73
    - and edge trigger combined, 76
    - applications of, 66
    - entered, 66
    - qualifying with edge, 66
  - patterns
    - defining for trigger, 75
    - entered, 75
    - exited, 75
    - irregular, 97
    - satisfying trigger qualifier, 75
    - transitions at left of display, 97
    - triggering on sequence of, 77
    - triggering on system failure, 78
  - performance
    - verify with self-tests, 151
  - performance characteristics, 196
  - acquisition system, 199
  - display system, 202
  - EMI, 204–206
  - environmental, 204–206
  - general, 204–206
  - horizontal system, 198
  - input channels, 197
  - measurement functions, 202
  - physical, 204–206
-



- 
- power requirements, 203
  - safety, 204–206
  - setup functions, 203
  - trigger system, 200
  - Performance Test Record, 178
    - record test results in, 177
    - verify voltage readings, 169
  - period measurement, 91
    - using cursors, 91
  - pivoting handle, 28
  - pixel memory, 58, 111
    - clearing, 116
    - recalling contents of, 115
    - saving trace waveform to, 114
  - poor uses for edge trigger, 65
  - poor uses for pattern trigger, 66
  - Position knob, 37, 50
  - position of cursors, 91
  - position of time reference
    - concepts, 133
    - in acquisition memory, 83–85
  - position of trigger event, 70
  - positioning channels, 50
  - positive width measurement, 91
  - post-trigger buffer, 70, 130
  - pouch, 24–26
  - power cord
    - connecting to analyzer, 27
    - disconnect before servicing, 181
    - remove before measuring voltages, 168
    - remove before servicing, 164–167
  - power requirements
    - performance characteristics, 203
  - power supply
    - adjusting voltages, 160–161
    - blown fuse, 168
    - hazardous voltages, 181
    - location of adjustments, 161
    - making dummy load, 158
    - measure fan voltage, 167
    - measure LVPS voltages, 168
    - measuring voltages, 161, 166
    - of circuit under test, 42–43
    - removing, 187
    - to adjust, 160–161
    - troubleshooting, 155
    - voltage measurements, 161
  - power switch, 27
    - power requirements, 203
    - safety, 204–206
    - setup functions, 203
    - trigger system, 200
  - power switch shaft
    - removing, 187
  - power-on, 27
    - self-test, 27
  - pre-trigger buffer, 70, 130
  - predefine test configurations, 112
  - predefined labels, 60–63
  - preset configuration, 119
  - print
    - cancel or stop, 88
    - interface modules used, 81
    - message, 212–213
    - status line, 81
    - waveform display, 81, 88
  - probe
    - attach every third ground, 142
    - circuit models, 140
    - grounding, 140
    - grounding concepts, 139–142
    - high-frequency circuit, 140
    - inductance, 141
    - loading concepts, 139–142
    - low-frequency circuit, 139–142
  - probe cable, 42–43
  - probe calibrator
    - performance characteristics, 203
  - probe leads
    - removing from cable, 43
  - probe tip design, 140
  - probes
    - connecting grabbers, 42–43
    - shorting together, 42–43
  - probing concepts
    - circuit under test, 139–142
  - probing practices, 142
  - problems
    - obtain HP service, 123
    - solving, 122
    - trace display, 123–124
    - with channels, 125
  - procedures
    - to test threshold accuracy, 169
    - to test time interval accuracy, 173
    - to verify correct operation, 150
  - process
    - acquisition, 70–71
  - pulse generator
    - connect to for test, 174
    - enabling to acquire data, 177
    - for testing time interval accuracy, 173
    - setting up, 175
  - pulse train
    - triggering on, 77
  - pulse transitions
    - of glitches, 143–148
- Q**
- qualifiers
    - satisfy to trigger analyzer, 79
  - qualifying trigger pattern using external trigger input, 108
- R**
- rackmount kit, 24–26
  - rate of trigger outputs, 110
  - Re-ordering channels, 50
  - readout of cursors, 91
  - readout settings and indicators, 95
  - recall
    - configuration, 113
    - memory setup, 112
    - setup, 115–116, 118
    - trace memory, 111
    - trace waveform, 115
  - reconstructed waveform
    - for glitch capture, 144
  - record test results
    - in Performance Test Record, 178
  - reference point
    - for hold time measurement, 102
    - for setup time measurement, 100
  - relating channels and circuit signals, 40
  - relationship between key color and function, 37
  - relationship of sweep speed and sample periods, 48
  - relationships
    - timebase and analyzer, 129–138
-

- 
- removing
    - and replacing assemblies, 181
    - cabinet, 182
    - display, 185
    - fan, 183
    - front panel, 184
    - handle, 189
    - keyboard, 188
    - power supply, 187
    - system board, 186
  - removing probe leads, 43
  - repetitive acquisition
    - concepts of behavior, 131
  - repetitive waveforms
    - and edge trigger, 65
  - replaceable parts, 180
    - descriptions and part numbers, 193
    - exploded view, 192
    - list for analyzer, 193
    - ordering, 191–194
    - using the mail order system, 191–194
  - replaceable parts list, 193
  - replacement
    - list, 193
  - reset setup, 119
  - resetting the analyzer, 123
  - resistance of impedance, 139–142
  - resistors
    - for dummy load, 158
    - for test connectors, 156–157
  - restore
    - configuration, 113
    - default configuration, 113
  - results
    - accumulating, 58
    - where displayed, 41
  - results of tests
    - record in Performance Test Record, 178
  - reversing Autoscale, 44–45
  - ribbon cable
    - disconnect to remove display, 185
    - disconnect to remove front panel, 184
    - disconnect to remove power supply, 187
    - disconnect to remove system board, 186
    - for LVPS, 166
  - Right
    - time reference position, 83–85
  - ringing in voltage model, 141
  - risetime in voltage model, 141
  - ROM and RAM self-tests, 151–152
  - RS-232 Interface module, 111
  - Run, 46
    - and auto trigger, 71, 131
    - and Erase, 58
    - and trigger, 65
  - run mode
    - and acquisition process, 70–71
  - run self-tests, 152–154
  - S**
  - safety certification, 204–206
  - safety summary
    - read before servicing, 181
  - sample period
    - relationship to sweep speed, 48
    - varied as function of timebase, 129–138
  - sampling, 55
  - sampling intervals, 130
    - affect delay value, 133
  - sampling period, 39
    - affects measurement results, 137
  - sampling rate
    - increase to capture glitch, 144
    - insufficient to capture glitch, 144
    - reasons to increase, 145
    - sufficient for display, 147
  - save
    - configuration, 112–113
    - setup, 117
    - waveform, 112, 114
  - screen
    - erasing, 58
  - searching for trigger, 70–71
  - Select knob, 37, 50, 73
    - choosing edge trigger channel, 47, 72
    - using to select channels, 49
  - selecting
    - channels, 49–50
    - channels for pattern trigger, 73
    - time reference position, 83–85
  - self-tests, 27, 151
    - acquisition system, 154
    - display, 162–163
    - keyboard, 153–154
    - ROM and RAM, 152
    - run to check LVPS, 167
  - sequential output patterns
    - triggering on, 77
  - setting
    - cursor position, 91
    - DC offset for threshold test, 172
    - threshold voltages, 108
    - Time/div, 48
  - setting trigger condition
    - for external trigger input, 110
    - for trigger output, 110
  - setting up external trigger, 108
  - setting up function generator, 170, 175
  - setting up pattern trigger, 73
  - setting up pulse generator, 175
  - setting up the analyzer, 21
    - to test time interval accuracy, 176
  - settings
    - default configuration, 119
    - for graticule, 81, 87
    - of cursor readouts, 95
  - setup
    - factory default, 44–45
    - memory banner, 117–118
    - message, 213–214
    - recalling, 118
    - recalling after trace cleared, 116
    - recalling from memory, 115
    - reset, 119
    - saved when trace cleared, 116
    - saving to memory, 117
  - setup functions
    - performance characteristics, 203
  - setup memory, 111–112
    - save/recall, 113
    - softkey menu, 113
  - setup time, 100–101
    - measurement, 101
  - shielding, magnetic, 24–26
  - shipment, damaged
    - See damaged shipment
  - shorting probes, 42–43
  - shutdown
    - occurs when LVPS is too hot, 167
  - signal margin on external trigger, 109
  - signals
    - on system board, 166
  - Single, 56
    - and auto trigger, 71, 131
-

- 
- single-channel measurements, 94–97
    - calculation and values, 91
    - softkeys displayed, 91
    - where displayed, 41
  - single-shot acquisition, 56, 71, 132
    - concepts of behavior, 131
  - size
    - display, 163
    - of glitch captured, 143–148
  - skew
    - check with channel-to-channel delay, 98–99
  - softkey labels, 38, 41
  - softkeys, 37, 41
    - Adv, 69, 74–79
    - edge trigger, 47, 72
    - for setup memory, 113
    - for trace memory, 112
    - Label, 59–64
    - Logic levels, 54
    - Mode, 70–71
    - On/Off, 49
    - Pattern, 73
  - software
    - Benchlink for Microsoft Windows, 24–26
  - solutions to problems
    - channels, 125
    - trace display, 123–124
  - solving problems
    - See Testing and Troubleshooting chapter
  - sources
    - for trigger, 74–79
    - defining patterns and edges, 74
    - for trigger, 75
  - specifications
    - of service equipment, 164
    - performance, 196
    - threshold accuracy, 169
  - start channel, 98–99
    - and edge, 92
  - start delay measurement, 92
  - starting an acquisition, 46
  - state machine
    - triggering on outputs, 77
  - status indicators, 38–39
    - STORE, 58
  - status messages
    - where displayed, 41
  - Stop, 46
  - stop printing, 88
  - stopping an acquisition, 46
    - to increase trigger output rate, 107, 110
  - storage, 56
    - and Autostore, 58
  - sub bright, 163
  - supplied accessories
    - See accessories, supplied
  - sweep
    - adjusting, 93
  - sweep displays
    - delayed, 80–81
    - main, 81
  - sweep speed, 39
    - affects acquisition memory, 130
    - affects sampling interval, 130
    - and missed trigger, 71, 131
    - increase to achieve accuracy, 137
    - reasons to increase, 145
    - relationship to instrument operating parameters, 48
    - slower affects memory fill, 137
    - See also timebase
  - switch
    - power, 187
  - synchronizing display to circuit, 65
  - system board
    - removing, 186
    - replacing/exchanging, 190
    - signals, 166
  - system failure
    - example of triggering on, 78
- T**
- t1 and t2 cursors, 89, 94–95
  - temperature
    - warm up, 159
  - test accessories
    - building, 155
  - test configurations
    - saving, 117
    - saving and recalling, 112
  - test connectors, 156–157
    - order for dummy load, 158
  - test ports, design in, 142
  - test results
    - record in Performance Test Record, 178
  - test setup
    - for thresholds, 171
    - for time interval accuracy, 174
  - test thresholds, 172
  - testing
    - the analyzer, 150
    - threshold accuracy, 169
    - time interval accuracy, 173
  - tests
    - acquisition system, 154
    - built into the analyzer, 151
    - keyboard, 153–154
    - ROM and RAM, 152
  - things to check
    - fan running?, 167
    - for channel problems, 125
    - for trace display problems, 123–124
    - LVPS voltages, 165–167
    - Performance Test Record, 169
    - signals on system board, 166
  - threshold, 55
    - accuracy, 169
    - test settings, 172
    - test setup, 171
  - threshold tests
    - using test accessories, 155
  - threshold voltage
    - setting, 54
  - threshold voltages
    - for external trigger input, 108
    - setting, 53
  - thresholds
    - message, 214
    - preset configuration, 119
  - time interval
    - of auto trigger, 70, 131
  - time interval accuracy test
    - acquiring data, 177
    - connecting equipment for, 174
    - setting up analyzer, 176
    - setting up equipment, 175
  - time interval tests
    - using test accessories, 155
  - time readout, 94–95
  - time reference
    - adjusting delay, 86
    - example, 134
    - setting position of, 83–85
-

- 
- time reference concepts, 133
  - time reference indicator, 39
    - displayed, 84
  - time reference position
    - concepts, 133
  - Time/div, 39
    - and missed trigger, 71, 131
    - knob, 37
    - setting, 48
    - using vernier to decrease step interval, 48
  - Time/div setting
    - changing in delayed sweep, 82
    - different for delayed and main sweeps, 82
    - for graticule divisions, 87
  - timebase
    - affects sample period, 129–138
    - and missed trigger, 71, 131
    - choose to represent events, 145
    - concepts, 129–138
    - preset configuration, 119
    - setting, 37, 39, 48
    - setting during Autoscale, 45
    - varying during run, 138
  - tolerance of power supply
    - adjusting, 160–161
    - measuring voltage, 161
  - TORX drivers, 181
  - trace
    - clearing from memory, 116
    - display problems, 123–124
  - trace memory, 111
    - message, 214
    - save/recall, 112
    - softkey menu, 112
  - trace waveform
    - recalling from memory, 115
    - saving to memory, 114
  - training board
    - See training kit
  - training kit, 24–26
  - transition time, 141
  - transitions
    - in hold time measurement, 103
    - in setup time measurement, 101
    - on start and end channels, 99
    - used in measurement, 96
  - transitions of glitches, 143–148
  - triangle indicators
    - empty (trigger delay), 84
    - solid (trigger position), 84
  - trigger, 65
    - action to cause, 71, 132
    - advanced, 67, 74–79
    - analyzer from other instruments, 104
    - and acquisition, 46
    - AND, OR, then operators, 75
    - defining edges, 74
    - defining patterns, 75
    - duration operator, 75
    - edge, 47, 72
    - entered and exited operators, 75
    - missed in certain conditions, 71, 131
    - occurs operator, 75
    - on microprocessor system failure, 78
    - on pulse train, 77
    - on sequential patterns, 77
    - operators, 74–79
    - other instruments, 104, 107
    - pattern, 66, 73
    - preset configuration, 119
    - setting during Autoscale, 45
    - sources, 74–79
  - trigger concepts
    - trigger may be missed, 131
    - trigger may not be stored, 133
  - trigger definition
    - experimenting with, 76
  - trigger event
    - adjusting delay, 86
    - position in acquisition memory, 70, 83–85
  - trigger functions, 132
  - trigger mode, 70–71
    - Auto, 39
    - Normal, 39
  - trigger mode vs. trigger type, 71
  - trigger modes
    - Auto, 131
    - Normal, 131
  - trigger not found
    - and auto trigger, 70, 131
  - trigger output, 104
    - BNC, 110
    - condition satisfied, 107
    - generated at various rates, 110
    - use for single-shot events, 107
  - trigger output rate
    - affected by overhead, 110
    - increase, 110
  - trigger position
    - indicators displayed, 84
  - trigger rate
    - affected by overhead, 107
  - trigger system
    - performance characteristics, 200
  - trigger type vs. trigger mode, 71
  - triggering capabilities
    - extended, 104
  - troubleshooting the analyzer, 164
  - troubleshoot power supply
    - using dummy load, 155
  - troubleshooting
    - accessories, building, 155
    - the analyzer, 150, 165–167
  - TTL threshold, 53–54
  - turn off cursors, 94–95
  - turning channels on and off, 49
  - turning on power, 27
- U**
- undo Autoscale, 44–45, 113, 119
  - unexpected trace display, 124
  - unhooking power switch shaft, 187
  - unique states in waveform and pattern
    - trigger, 66
  - user interface
    - overview of, 35–36
    - user-defined threshold, 53–54
  - using Auto trigger mode, 76
  - using color, 30
  - using Normal trigger mode, 76
  - using the analyzer
    - process of, 18, 20
  - Utility key
    - used to run self-tests, 152–154
- V**
- variables in probing, 142
  - verify performance
    - with self-tests, 151
  - vernier, 48
  - vertical
    - linearity, 163
    - size, 163
-

- 
- vertical hold
    - adjusting, 162–163
  - vertical lines
    - in delayed sweep display, 82
  - viewing acquired data
    - delayed sweep, 80
    - graticule, 81
    - printing, 81
  - violation
    - of hold time, 102–103
    - of setup time, 100–101
  - voltage
    - adjustment, 160–162
    - behavior in probe grounding, 141
    - logic threshold, 53–54
    - measurements, 161
    - models, 141
  - voltages
    - power supply, 166
    - signals on system board, 166
  - W**
  - warm up
    - analyzer, before adjusting, 159
    - analyzer, before testing, 170, 175
    - test equipment, 170, 175
  - waveform
    - choosing a timebase setting, 145
    - clearing from memory, 116
    - cursor measurements, 91
    - delayed sweep concepts, 133
    - disjoint edges, 146
    - display area, 38
    - does not show grounding problems, 141
    - measurements, 91
    - recalling from memory, 115
    - reconstructing for glitch capture, 144
    - saving to memory, 114
  - waveform display, 40, 55
    - and Autostore, 58
    - and labels, 59
    - erasing, 58
  - waveform events
    - and pattern trigger, 66
    - apply advanced trigger, 76
    - measuring time or values, 89
    - picking known sequence, 76
    - questions to find sequence, 76
    - setting up display, 76
  - waveform parameters
    - measuring, 96–97
  - width measurements, 91, 96–97
  - widths
    - calculated, 97
  - Z**
  - zoom portion of waveform using delayed sweep, 80

# DECLARATION OF CONFORMITY

according to ISO/IEC Guide 22 and EN 45014

**Manufacturer's Name:** Hewlett-Packard Company

**Manufacturer's Address:** Colorado Springs Division  
1900 Garden of the Gods Road  
Colorado Springs, CO 80907 U.S.A.

declares, that the product

**Product Name:** Logic Analyzer

**Model Number(s):** HP 54620A/C

**Product Option(s):** All

conforms to the following Product Specifications:

**Safety:** IEC 348:1978 / HD 401 S1:1981  
UL 1244  
CSA-C22.2 No. 231 (Series M-89)

**EMC:** CISPR 11:1990 / EN 55011:1991 Group 1 Class A  
IEC 555-2:1982 + A1:1985 / EN 60555-2:1987  
IEC 555-3:1982 + A1:1990 / EN 60555-3:1987 + A1:1991  
IEC 801-2:1991 / EN 50082-1:1992 4 kV CD, 8 kV AD  
IEC 801-3:1984 / EN 50082-1:1992 3 V/m, {1kHz 80% AM, 27-1000 MHz}  
IEC 801-4:1988 / EN 50082-1:1992 0.5 kV Sig. Lines, 1 kV Power Lines

## Supplementary Information:

The product herewith complies with the requirements of the Low Voltage Directive 73/23/EEC and the EMC Directive 89/336/EEC and carries the CE marking accordingly.

This product was tested in a typical configuration with Hewlett-Packard test systems.

Colorado Springs, 10/24/95

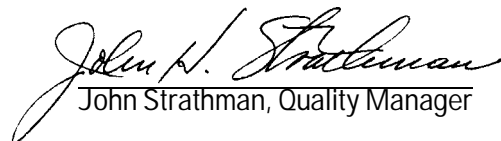
  
John Strathman, Quality Manager

European Contact: Your local Hewlett-Packard Sales and Service Office or Hewlett-Packard GmbH, Department ZQ / Standards Europe, Herrenberger Strasse 130, D-71034 Böblingen Germany (FAX: +49-7031-14-3143)



---

# HP 54620 Documentation

## **Start Here**

HP 54620A/C User's Guide

## **Service Information**

Included in the HP 54620A/C User's Guide.

## **Programming Information**

HP 54620A/C Programmer's Guide

HP 54620A/C Programmer's Reference is supplied as a help file on a 3.5" diskette. The diskette includes a help file viewer for Microsoft Windows 3.1 and Microsoft Write editor versions of the files. ASCII files are also supplied.





© Copyright Hewlett-Packard Company 1994, 1995  
All Rights Reserved.

Reproduction, adaptation, or translation without prior written permission is prohibited, except as allowed under the copyright laws.

Microsoft is a registered trademark of Microsoft Corporation.

### Document Warranty

The information contained in this document is subject to change without notice.

**Hewlett-Packard makes no warranty of any kind with regard to this material, including, but not limited to, the implied warranties of merchantability or fitness for a particular purpose.**

Hewlett-Packard shall not be liable for errors contained herein or for damages in connection with the furnishing, performance, or use of this material.

### Safety

This apparatus has been designed and tested in accordance with IEC Publication 348, Safety Requirements for Measuring Apparatus, and has been supplied in a safe condition. This is a Safety Class I instrument (provided with terminal for protective earthing). Before applying power, verify that the correct safety precautions are taken (see the following warnings). In addition, note the external markings on the instrument that are described under "Safety Symbols."

### Warning

- Before turning on the instrument, you must connect the protective earth terminal of the instrument to the protective conductor of the (mains) power cord. The mains plug shall only be inserted in a socket outlet provided with a protective earth contact. You must not negate the protective action by using an extension cord (power cable) without a protective conductor (grounding). Grounding one conductor of a two-conductor outlet is not sufficient protection.
- Only fuses with the required rated current, voltage, and specified type (normal blow, time delay, etc.) should be used. Do not use repaired fuses or short-circuited fuseholders. To do so could cause a shock of fire hazard.

- Service instructions are for trained service personnel. To avoid dangerous electric shock, do not perform any service unless qualified to do so. Do not attempt internal service or adjustment unless another person, capable of rendering first aid and resuscitation, is present.

- If you energize this instrument by an auto transformer (for voltage reduction), make sure the common terminal is connected to the earth terminal of the power source.

- Whenever it is likely that the ground protection is impaired, you must make the instrument inoperative and secure it against any unintended operation.

- Do not operate the instrument in the presence of flammable gasses or fumes. Operation of any electrical instrument in such an environment constitutes a definite safety hazard.

- Do not install substitute parts or perform any unauthorized modification to the instrument.

- Capacitors inside the instrument may retain a charge even if the instrument is disconnected from its source of supply.

- Use caution when exposing or handling the CRT. Handling or replacing the CRT shall be done only by qualified maintenance personnel.

### Safety Symbols



Instruction manual symbol: the product is marked with this symbol when it is necessary for you to refer to the instruction manual in order to protect against damage to the product.



Hazardous voltage symbol.



Earth terminal symbol: Used to indicate a circuit common connected to grounded chassis.

### WARNING

The Warning sign denotes a hazard. It calls attention to a procedure, practice, or the like, which, if not correctly performed or adhered to, could result in personal injury. Do not proceed beyond a Warning sign until the indicated conditions are fully understood and met.

### CAUTION

The Caution sign denotes a hazard. It calls attention to an operating procedure, practice, or the like, which, if not correctly performed or adhered to, could result in damage to or destruction of part or all of the product. Do not proceed beyond a Caution symbol until the indicated conditions are fully understood or met.

---

## Product Warranty

This Hewlett-Packard product has a warranty against defects in material and workmanship for a period of three years from date of shipment. During the warranty period, Hewlett-Packard Company will, at its option, either repair or replace products that prove to be defective. For warranty service or repair, this product must be returned to a service facility designated by Hewlett-Packard.

For products returned to Hewlett-Packard for warranty service, the Buyer shall prepay shipping charges to Hewlett-Packard and Hewlett-Packard shall pay shipping charges to return the product to the Buyer. However, the Buyer shall pay all shipping charges, duties, and taxes for products returned to Hewlett-Packard from another country.

Hewlett-Packard warrants that its software and firmware designated by Hewlett-Packard for use with an instrument will execute its programming instructions when properly installed on that instrument. Hewlett-Packard does not warrant that the operation of the instrument software, or firmware will be uninterrupted or error free.

## Limitation of Warranty

The foregoing warranty shall not apply to defects resulting from improper or inadequate maintenance by the Buyer, Buyer-supplied software or interfacing, unauthorized modification or misuse, operation outside of the environmental specifications for the product, or improper site preparation or maintenance.

**No other warranty is expressed or implied. Hewlett-Packard specifically disclaims the implied warranties of merchantability or fitness for a particular purpose.**

## Exclusive Remedies

The remedies provided herein are the buyer's sole and exclusive remedies. Hewlett-Packard shall not be liable for any direct, indirect, special, incidental, or consequential damages, whether based on contract, tort, or any other legal theory.

## Assistance

Product maintenance agreements and other customer assistance agreements are available for Hewlett-Packard products.

For any assistance, contact your nearest Hewlett-Packard Sales Office.

## Certification

Hewlett-Packard Company certifies that this product met its published specifications at the time of shipment from the factory. Hewlett-Packard further certifies that its calibration measurements are traceable to the United States National Institute of Standards and Technology, to the extent allowed by the Institute's calibration facility, and to the calibration facilities of other International Standards Organization members.

## About this edition

This is the first edition of the *HP 54620A/C Logic Analyzer User and Service Guide*.

Publication number  
54620-97011

Printed in USA.

Edition dates are as follows:  
First edition, October 1995

New editions are complete revisions of the manual. Update packages, which are issued between editions, contain additional and replacement pages to be merged into the manual by you. The dates on the title page change only when a new edition is published.

A software or firmware code may be printed before the date. This code indicates the version level of the software or firmware of this product at the time the manual or update was issued. Many product updates do not require manual changes; and, conversely, manual corrections may be done without accompanying product changes. Therefore, do not expect a one-to-one correspondence between product updates and manual updates.

The following list of pages gives the date of the current edition and of any changed pages to that edition.

All pages original edition